

E | EKSTRAKCJA
E | EXTRAKTION
E | EXTRACTION
E | EXTRACTION

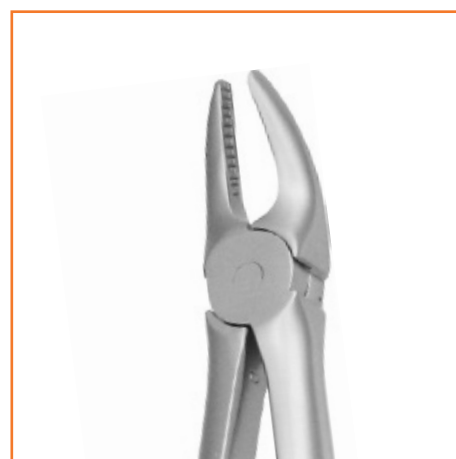

REICO-lux Instrumente

REICO-lux instruments
Instruments REICO-lux

saving hard and soft tissue

modern tooth extraction

tactile working

direct and controlled power transfer



Mit den REICO-lux-Instrumenten erhalten Sie ein modernes Instrumentarium für die Zahnextraktion nach dem Prinzip der Minimalinvasivität.

Das Griffdesign, auf Druck und Zug ausgerichtet, ermöglichteintaktilerArbeiten ohne angrenzende Strukturen zu zerstören. Mit dem neuen Griff ist eine direkte und kontrollierte Kraftübertragung möglich.

Für die schonende Entfernung nicht erhaltungsfähiger Zähne ist dies das perfekte Instrumentarium.



With the REICO-lux-range you get a modern set of instruments for dental extraction, appropriate for the principle of minimal invasiveness.

The handle design aligned to pressure and tug, allows tactile working without destroying the adjacent structures. Direct and controlled power transfer is possible with the new handle.

This is the perfect instrument for the careful and faultless removal of non-preservable teeth.



Avec nos instruments REICO-lux vous obtenez une instrumentation pour l'extraction moderne selon le principe de la chirurgie invasive minimisée.

Le design du manche permet un travail tactile sans blesser les zones proximales. Le nouveau manche permet une transmission de force directe et contrôlée.

Ces instruments sont parfaits pour une avulsion en douceur des dents endommagées.

REICO-lux Instrumente – Anwendung

REICO-lux instruments – application
Instruments REICO-lux – application



02-753-05 C Desmotom, „Bernard“



02-753-10 C Bereich: distal
Area: distal
Zone: distale



02-753-15 C Bereich: mesial
Area: mesial
Zone: mesiale



02-753-31 C Bereich: approximal (mesial, distal)
02-753-33 C Area: approximal (mesial, distal)
Zone: approximal (mesial, distal)



02-753-41 C zum Lösen des Zahns
02-753-43 C for loosening of the tooth
un relâchement souple de la dent



Nicht für den axial-hebelnden Gebrauch geeignet.
Not suitable for use as axial levers.
Ne pas utiliser comme levier axial.

Nichtbeachtung der Gebrauchshinweise kann zum Bruch führen. Für diese Schäden können wir keine Haftung übernehmen!
Disregard of the usage instructions may result in breakage. We can accept no liability for this damage!
Un non-respect des instructions peut provoquer la fracture de l'instrument. Pour ces dommages nous ne prenons aucune responsabilité!





REICO-lux Instrumente

REICO-lux instruments
Instruments REICO-lux

comfort line

REICO-lux Instrumente

REICO-lux instruments
Instruments REICO-lux

comfort line

02-753-05 C *comfort line*
gerade
straight
droits 171 mm
Desmotom „Bernard“

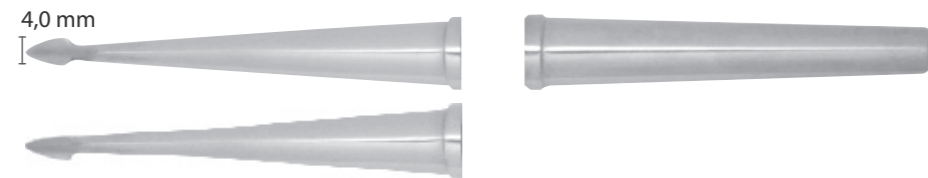

02-753-31 C *comfort line*
gerade
straight
droits 171 mm
Bereich: approximal (mesial, distal)
Area: approximal (mesial, distal)
Zone: approximal (mesiale, distale)

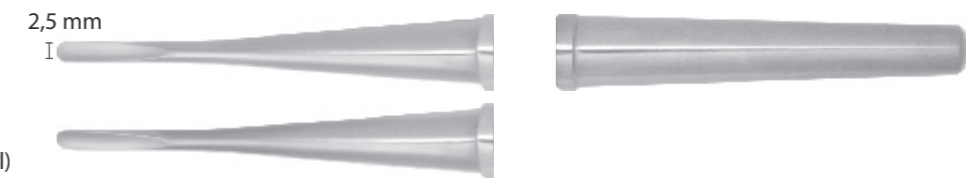

02-753-11 C *comfort line*
abgewinkelt
angulated
angulé 171 mm
Bereich: distal / Desmotom
Area: distal / Desmotom
Zone: distale / Desmotom

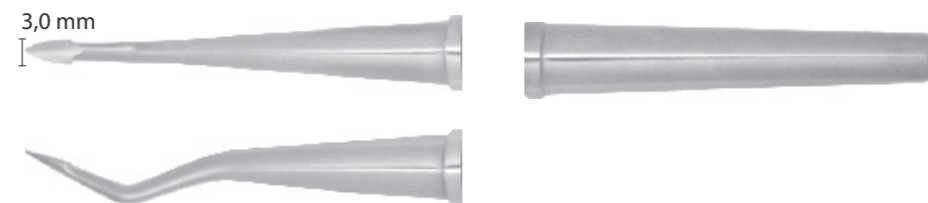

02-753-33 C *comfort line*
gerade
straight
droits 171 mm
Bereich: approximal (mesial, distal)
Area: approximal (mesial, distal)
Zone: approximal (mesiale, distale)

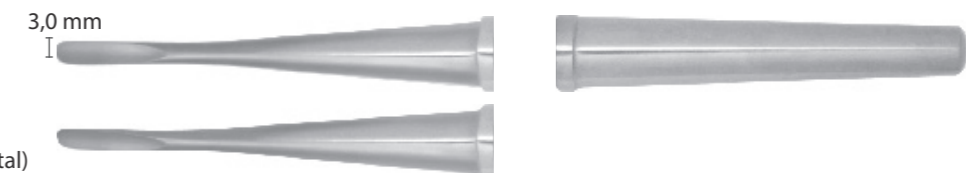

02-753-16 C *comfort line*
abgewinkelt
angulated
angulé 171 mm
Bereich: mesial / Desmotom
Area: mesial / Desmotom
Zone: mesiale / Desmotom

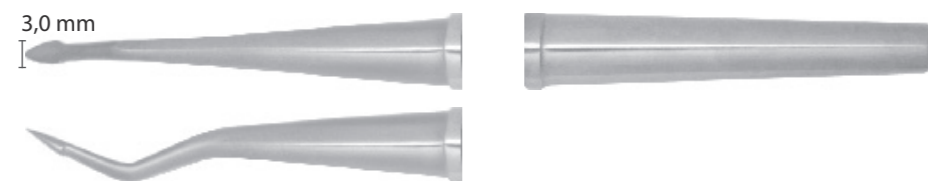

02-753-41 C *comfort line*
gebogen
curved
courbé 171 mm
zum Lösen des Zahnes
for loosening of the tooth
un relachement souple de la dent

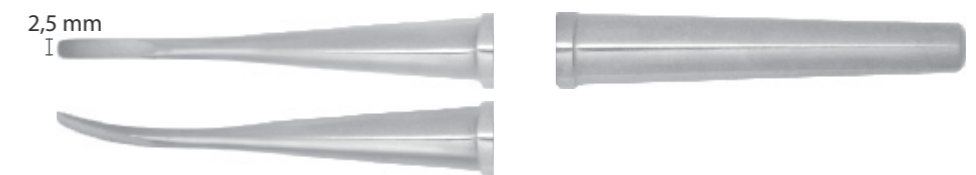

02-753-10 C *comfort line*
abgewinkelt
angulated
angulé 171 mm
Bereich: distal
Area: distal
Zone: distale



02-753-43 C *comfort line*
gebogen
curved
courbé 171 mm
zum Lösen des Zahnes
for loosening of the tooth
un relachement souple de la dent

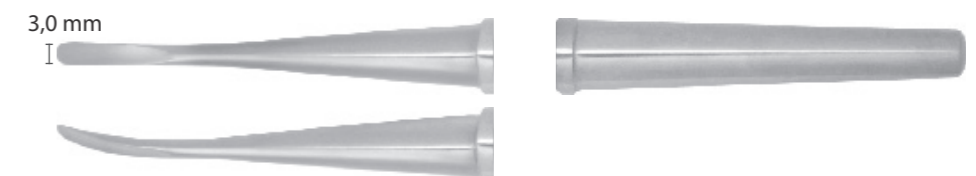

02-753-15 C *comfort line*
abgewinkelt
angulated
angulé 171 mm
Bereich: mesial
Area: mesial
Zone: mesiale



REICO-lux Instrumente sollten regelmäßig (nach 5-6 Anwendungen) nachgeschliffen werden. Optimal dafür: Schleifsteine 02-9500-60 und 02-9500-30 (Kapitel C)

REICO-lux instruments should be sharpened regularly (after 5-6 applications). Particularly suitable: abrasive 02-9500-60 and 02-9500-30 (Chapter C)

Les instruments REICO-lux doivent être régulièrement réaffûtés (après 5-6 utilisations). Nous recommandons : Pierre d'affûtage 02-9500-60 et 02-9500-30 (Chapitre C)



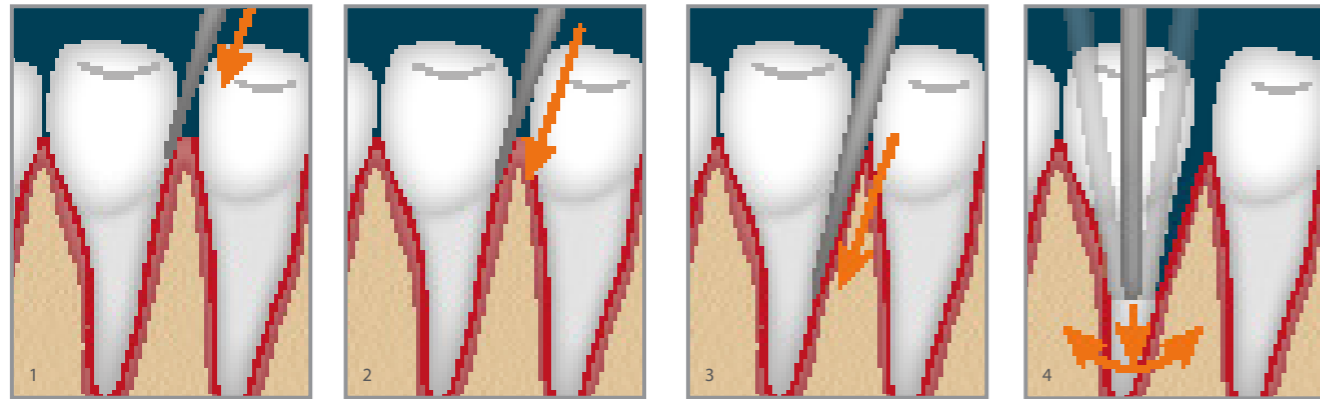

Perioluxe

Periolux
Périoluxe



 Periolux seitlich am Zahn anbringen (1), die Zahnalveole erweitern (2), die Ligamente durchtrennen (3) und den Zahn durch eine Drehbewegung aus dem Kiefer lösen (4). So entsteht eine minimale Gewebebeschädigung.

 Position the Periolux to the side of the tooth (1), enlarge the alveole (2), sever the ligament (3) and remove the tooth with a rotating circular motion from its socket (4). This results in minimal tissue damage.

 Placer le périolux au bord de la dent (1), l'alvéole s'élargit (2), sectionner les ligaments (3) et par un mouvement rotatif l'adent se détache facilement (4). Le résultat est un dommage minimal des tissus.



02-751-00	02-751-01	02-751-02
gerade straight droit	gerade straight droit	gerade straight droit
3,0 mm 140mm	4,0 mm 140mm	5,0 mm 140mm

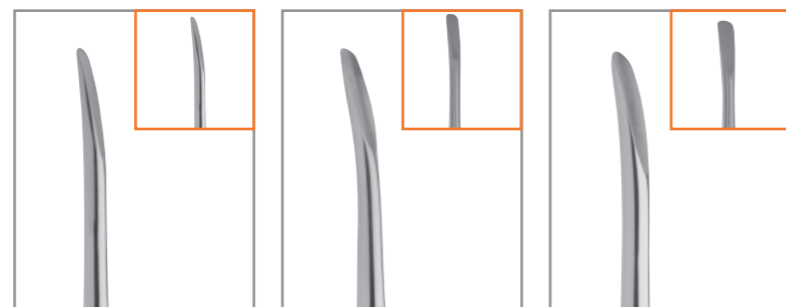

02-751-05	02-751-06	02-751-07
gebogen curved courbés	gebogen curved courbés	gebogen curved courbés
3,0 mm 140mm	4,0 mm 140mm	5,0 mm 140mm

Mini-Perioluxe

Mini-Periolux
Mini-Périoluxe

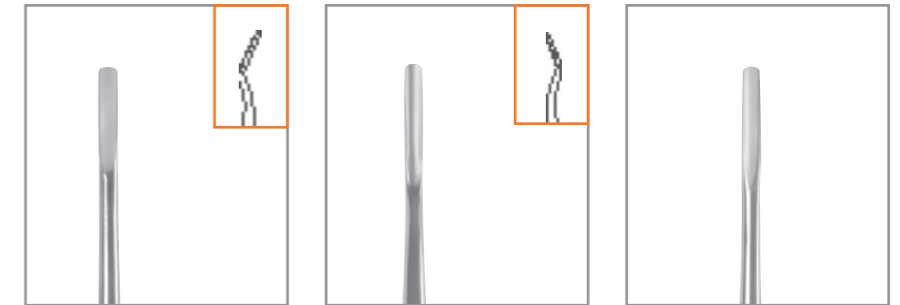

02-750-01	02-750-02	02-750-04
mesial mesial mésial	distal distal distal	gerade straight droit
2,5 mm 140mm	2,5 mm 140mm	2,5 mm 140mm



02-750-03	02-750-08	02-750-09
lanzenförmig lance lance	links gebogen left curved courbée à gauche	rechts gebogen right curved courbée à droite
4,0 mm 140mm	2,5 mm 140mm	2,5 mm 140mm



02-750-05	02-750-06	02-750-07
mesial mesial mésial	distal distal distal	gerade straight droit
5,0 mm 140mm	5,0 mm 140mm	5,0 mm 140mm

SWE | Perioluxe

SWE | Periolux
SWE | Périoluxe

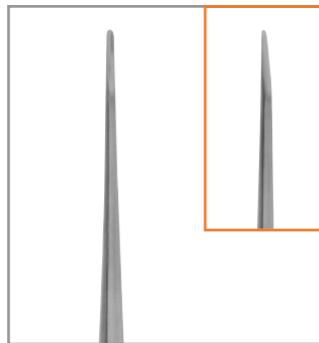

02-752-10
gerade # L1S
straight 1,0 mm
droit 165 mm
Anzuwenden wie ein Periotom
To use like a periotome
Utilisé comme periotome

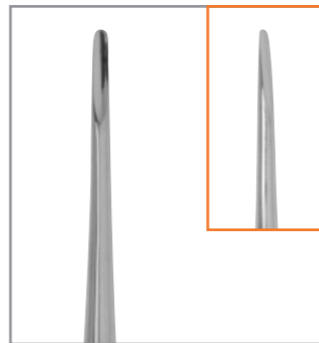

02-752-20
gerade # L2S
straight 2,0 mm
droit 165 mm
apikal und/oder interproximal
apical and/or interproximal
apical et/ou interproximal

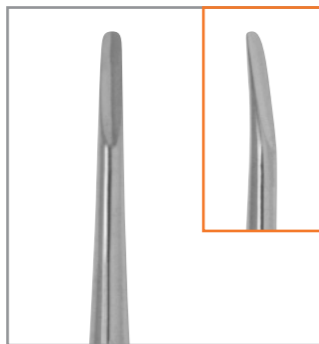

02-752-30
gebogen # L3C
curved 3,0 mm
courbés 165 mm
universeller Gebrauch/Starter
general use/starter
Utilisation générale/Starter

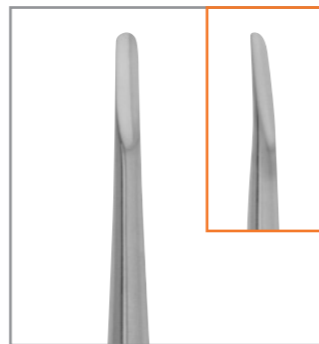

02-752-32
gerade # L3S
straight 3,0 mm
droit 165 mm
interproximal
interproximal
interproximal

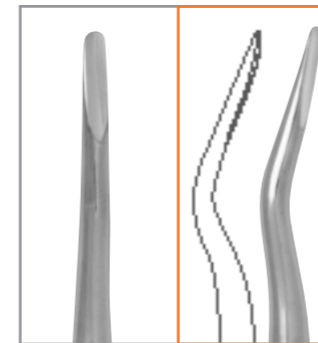

02-752-34
abgewinkelt # L3CA
contra-angled 3,0 mm
contre-anglé 165 mm
linguale und/oder distale Molaren
lingual and/or distal molars
lingual et/ou distal molaires

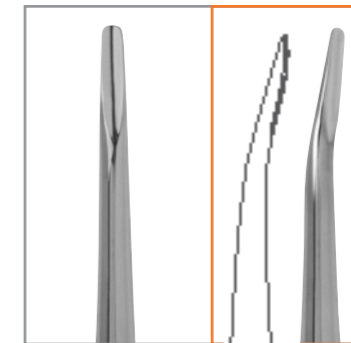

752-36
abgewinkelt # L3IC
contra-angled 3,0 mm
contre-anglé 165 mm
universal; lingual und/oder distal
general; lingual and/or distal
général; lingual et/ou distal

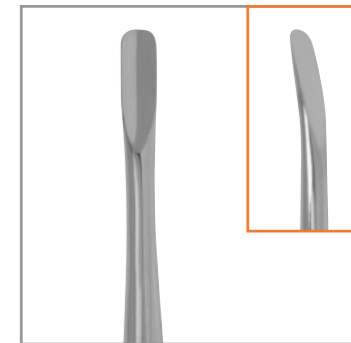

752-50
gebogen # L5C
curved 5,0 mm
courbés 165 mm
Universal; große Molarenwurzeln
general; large molar roots
général; racines de molaires larges



02-752-52
gerade # L5S
straight 5,0 mm
droit 165 mm
interproximal
interproximal
interproximal

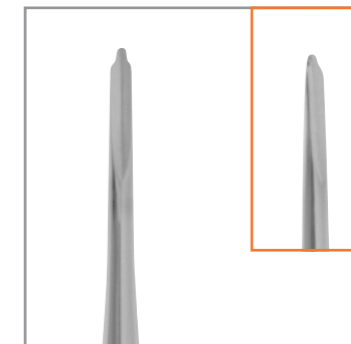

02-752-80
gerade # DE3
straight 3,0/1,5 mm
droit 165 mm
tief frakturierte/kariöse Wurzeln
deep fractured/decayed roots
fractures profondes et racines cariées



02-752-82
gerade # DE5
straight 5,0/3,0 mm
droit 165 mm
tief frakturierte/kariöse Wurzeln
deep fractured/decayed roots
fractures profondes et racines cariées

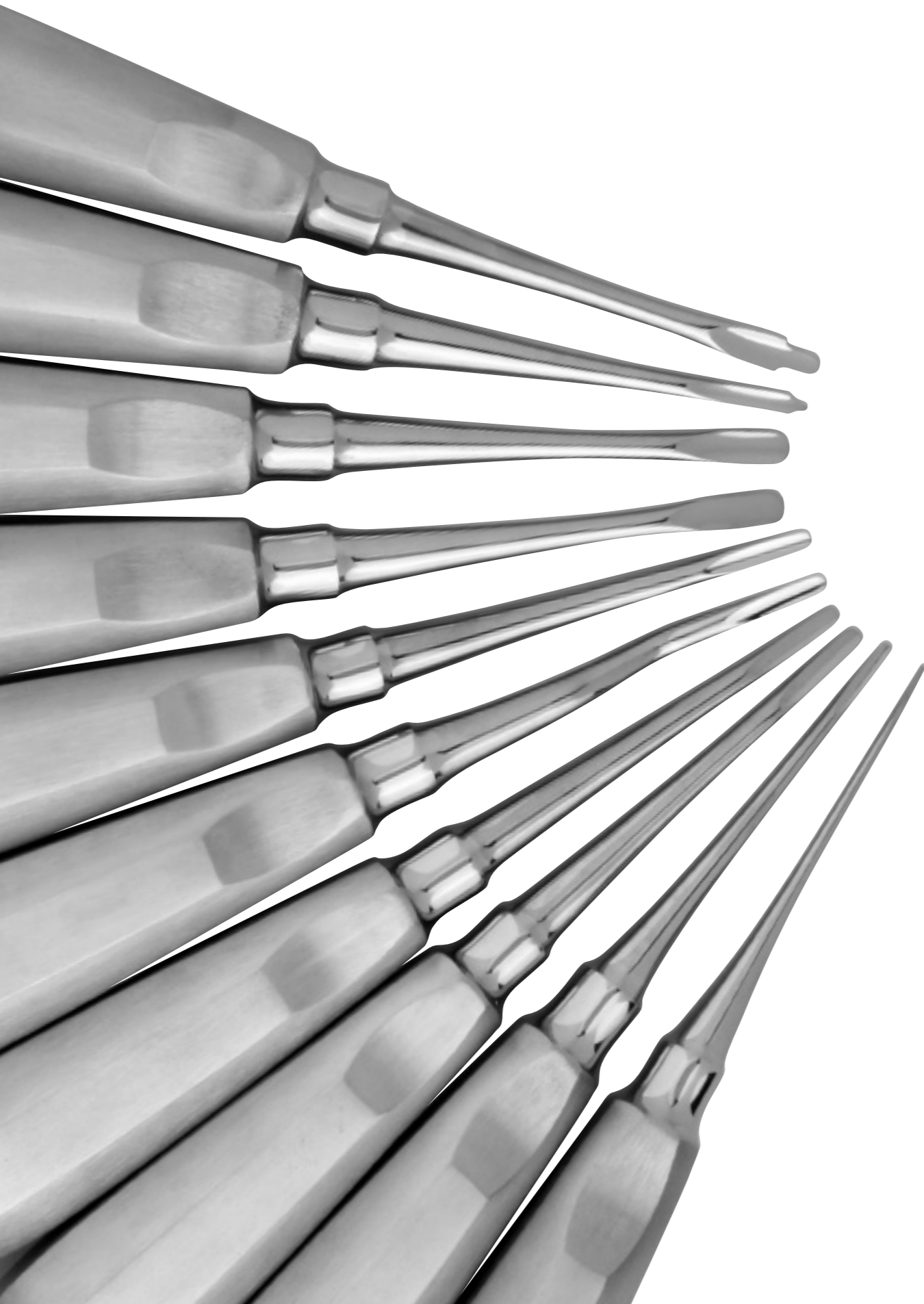

Periotome
 Periotomes
 Périotomes

comfort line

02-2500-15 C *comfort line*
 162 mm

gerade
 straight
 droit



02-2500-13 C *comfort line*
 162 mm

seitlichabgewinkelt
 laterally angled
 angulation latérale



02-2500-14 C *comfort line*
 162 mm

abgewinkelt
 angled
 angulé



02-2500-18 C *comfort line*
 171 mm

seitlichabgewinkelt/abgewinkelt
 laterally angled / angled
 angulé / angulé

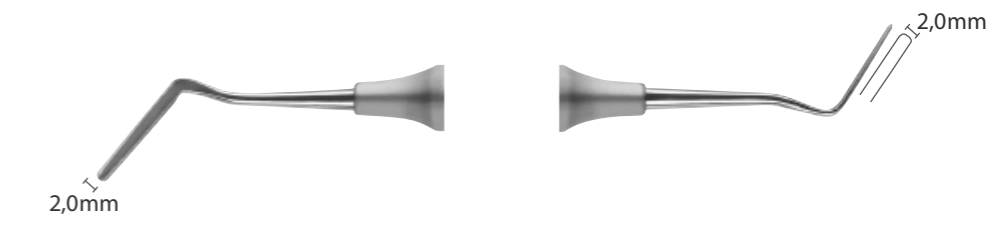

02-2500-17 C *comfort line*
 171 mm

seitlich abgewinkelt | gerade
 laterally angled | straight
 angulation latérale | droit

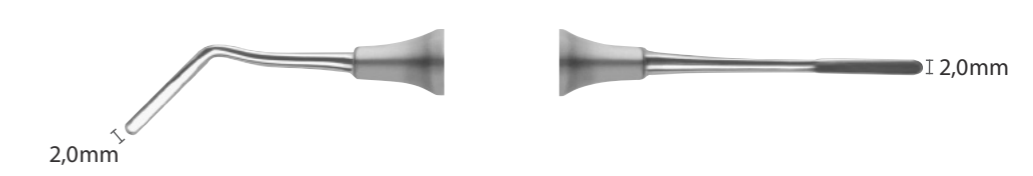

02-2500-19 C *comfort line*
 171 mm

abgewinkelt | gerade
 angled | straight
 angulé | droit

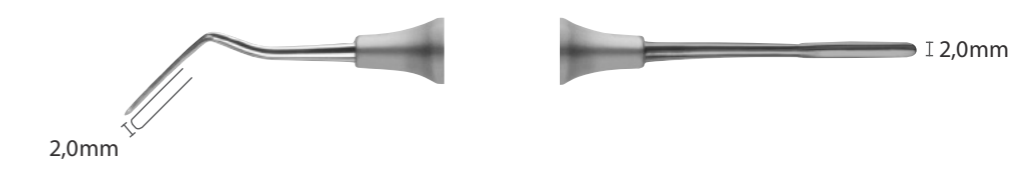

Syndesmotome

Syndesmotomes
Sindesmotomes

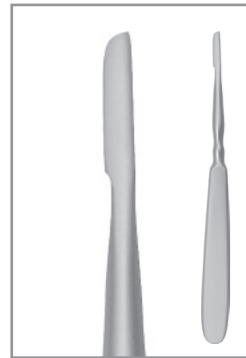

02-796-1
Chompret 165mm
Hohlgriff
Hollow handle
Poignée creuse



02-796-1 M
Griff massiv
Solid handle
Manche massif



02-796-2
Chompret 165mm
Hohlgriff
Hollow handle
Poignée creuse

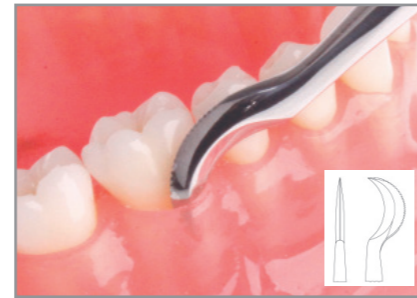

ACHTUNG
Die Syndesmotomes sind zur Durchtrennung der Ligamente und Entfernung frakturierter Wurzeln oder von Wurzelresten vorgesehen, aber keinesfalls als Wurzelheber einzusetzen. Bei Zuwiderhandlung wird keine Haftung übernommen.

ATTENTION
Syndesmotomes are intended to be used for the transection of ligaments and for the removal of fractured roots or root fragments. Under no circumstances they may be used as root elevators. In case of violation no liability is accepted.

ATTENTION
Les syndesmotomes doivent uniquement être utilisés pour sectionner des ligaments, enlever des racines fracturées ou des bouts de racine, mais ne doivent en aucun cas être utilisés comme élévateur. Les instructions d'emploi n'ont pas à être respectées, aucune responsabilité n'est acceptée.



02-796-3
Chompret 165mm
Hohlgriff
Hollow handle
Poignée creuse



02-796-7 S
Griff massiv
Solid handle
Manche massif



02-796-8
Griff massiv
Solid handle
Manche massif



02-796-7
Griff massiv
Solid handle
Manche massif



02-796-7 A
Hohlgriff
Hollow handle
Poignée creuse



02-796-17
Griff massiv, gezahnt
Solid handle, serrated
Manche massif, denteles



02-796-17 A
Hohlgriff, gezahnt
Hollow handle, serrated
Poignée creuse, denteles

Pivot-Point Instrumente – Anwendung

Pivot-Point Instruments – application
Instruments Pivot-Point – application



Durch den Parabelschliff an der Instrumentenspitze und das rautenförmige Plateau ist ein schonendes Eindringen in den Interdentalraum / Periodontalspalt optimal gewährleistet.

Bedingt durch die Formgebung sind durch eine 180° Drehung vier Luxationsbewegungen möglich, je 2x mesial und 2x distal. Das Instrument arbeitet während des Luxationsvorgangs mit 5-7 Hypomochlien (Dreh- und Stützbewegungen). Dadurch ist er jedem herkömmlichen Hebel deutlich überlegen.

Die Luxation wird besonders durch den Wellenschliff am Instrumentenrand begünstigt. Eine axial hebelnde Belastung der Instrumentenspitzen kann zu Bruch führen.



Due to the elliptically ground area on the instrument tip and the diamond-shaped plateau, gentle penetration into the interdental space or periodontal cleft is optimally guaranteed.

Through its ability to rotate 180° and its shape, four luxation movements are possible: 2x mesial and 2x distal. During luxation, the instrument operates with between 5-7 hypomochlions (rotation and supporting actions), which is significantly superior to any conventional elevator.

The grooves on the edge of the instrument provide especially efficient luxation. The instrument tips are not designed for axial leverage as this could lead to fracture.



Grâce à la taille elliptique de l'extrémité de l'instrument et de sa forme en losange, une pénétration atraumatique dans l'espace interdentaire ou l'espace parodontal est assurée de manière optimale.

La forme même permet aussi, par des rotations sur 180°, d'effectuer 4 mouvements de luxation, 2 du côté distal et 2 du côté mésial. Au cours de la luxation, l'extrémité travaille avec 5 à 7 sites d'hypomochlion (mouvements de rotation et d'appui). De ce fait, cet instrument est de loin supérieur aux élévateurs connus.

La luxation est particulièrement facilitée par les striures des bords tranchants de l'instrument. Une force de levier axiale peut provoquer la fracture de l'instrument.

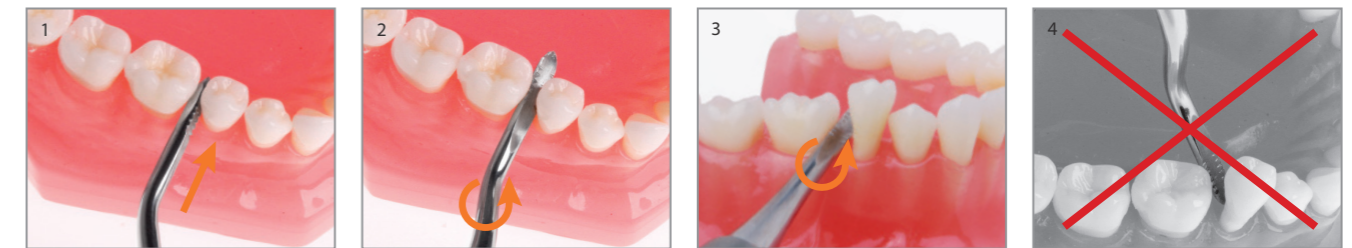

Die Pivot-Point Instrumente sind nicht für den axial-hebelnden Gebrauch geeignet. Nichtbeachtung der Gebrauchshinweise (Abb. 1-4) kann zu Bruch führen. Für diese Schäden können wir keine Haftung übernehmen!

The Pivot-Point Instruments are not suitable for use as axial levers. Disregard of the usage instructions (Abb. 1-4) may result in breakage. We can accept no liability for this damage!

Les instruments Pivot-Point ne doivent pas être utilisés comme levier axial. Un non-respect des instructions (image 1-4) peut provoquer la fracture de l'instrument. Pour ces dommages nous ne prenons aucune responsabilité!



02-675-05
gerade
straight
droit 163 mm
85
3,0 mm



02-675-10
gerade
straight
droit 163 mm
86
3,5 mm



02-675-15
gerade
straight
droit 163 mm
87
4,0 mm

Pivot-Point Instrumente

Pivot-Point Instruments
Instruments Pivot-Point



02-675-20
nachuntengebogen 163 mm
curved downwards # 85 U
coudé en bas 3,0 mm



02-675-22
nachuntengebogen 163 mm
curved downwards # 85 U
coudé en bas 3,5 mm



02-675-25
nachobengebogen 163 mm
curved upwards # 85 B
coudé en haut 3,0 mm

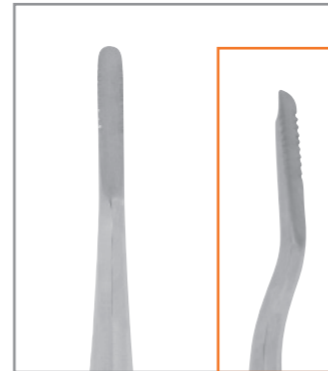

02-675-27
nachobengebogen 163 mm
curved upwards # 85 B
coudé en haut 3,5 mm



02-675-30
nachlinksgebogen 163 mm
curved to the left # 86 L
coudé à gauche 3,5 mm



02-675-35
nachrechtsgebogen 163 mm
curved to the right # 86 R
coudé à droite 3,5 mm

Wurzelheber

Root Elevators
Elévateurs de Racines

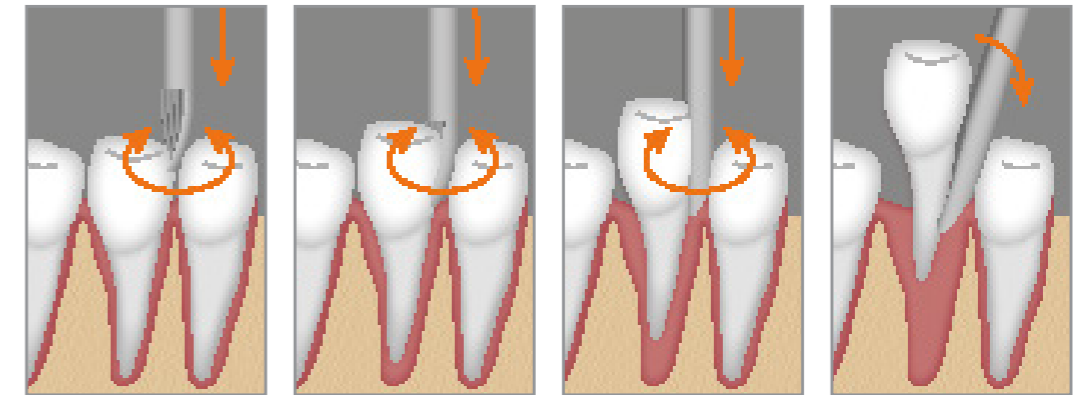

02-680-10
Kopp # R 4,0 mm
140mm

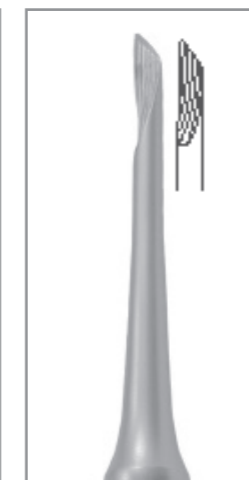

02-680-11
Kopp # L 4,0 mm
140mm

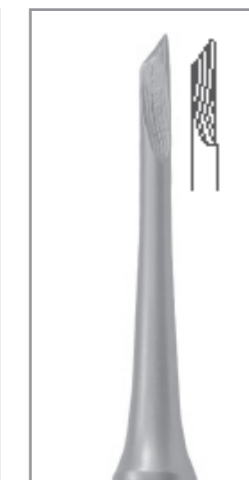

02-680-12
Kopp # R 3,5 mm
140mm

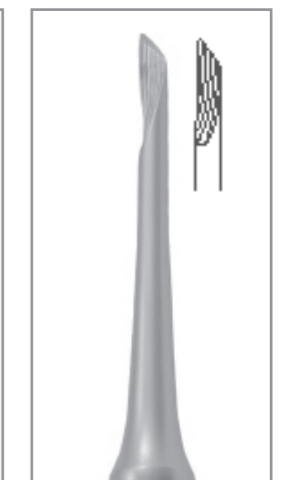

02-680-13
Kopp #L 3,5 mm
140mm

Bernard | Wurzelheber

Bernard | Root elevators
Bernard | Elévateurs de racines



Bernard Wurzelheber eignen sich besonders zur Entfernung frakturierter Wurzeln oder von Wurzelresten. Sie stellen eine Kombination aus Wurzelspitzenheber und Perioldar. Die Innenseite ist konkav und die Seitenkanten sind schneidend. Dadurch können bei drehenden Bewegungen, unter Anwendung von etwas Druck, die Ligamente getrennt und der Wurzelrest gelockert werden.



Bernard root elevators are particularly suitable for the excision of fractured roots or root fragments. They represent a combination of root tip elevators and perioluxes. The inner side is concave and the lateral edges are for cutting. This allows for rotary movements, and when applying slight pressure, the ligaments can be separated and the remaining root fragments can be loosened.



Les élévateurs de Bernard servent surtout à enlever des racines fracturées ainsi que des fragments de racines. Ils sont une combinaison entre élévateur et périoluxe. La partie inférieure est concave, les rebords sont tranchants. Par mouvement de rotation et légère pression les ligaments peuvent être séparés et les fragments de racines se détachent plus facilement.



02-794-60
60 4,0 mm
135mm



02-794-61
60 R 4,0 mm
135mm



02-794-62
60 L 4,0 mm
135mm

Wurzelheber

Root Elevators
Elévateurs de Racines



02-700-36
Heidbrink 140mm



02-700-37
Heidbrink 140mm



02-720-1
Apical #301 150mm



02-720-2
Apical #302 155mm



02-720-3
Apical #303 155mm



02-720-4
Apical #304 150mm



02-720-6
Seldin # 34S 150mm



02-720-7
Seldin # 34 155mm

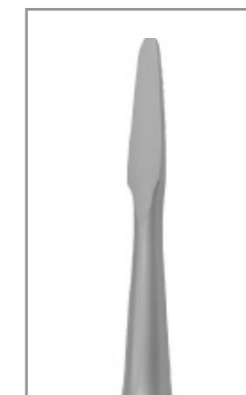

02-720-15
Seldin # 2 160mm



Wurzelheber
Root Elevators
Elévateurs de Racines

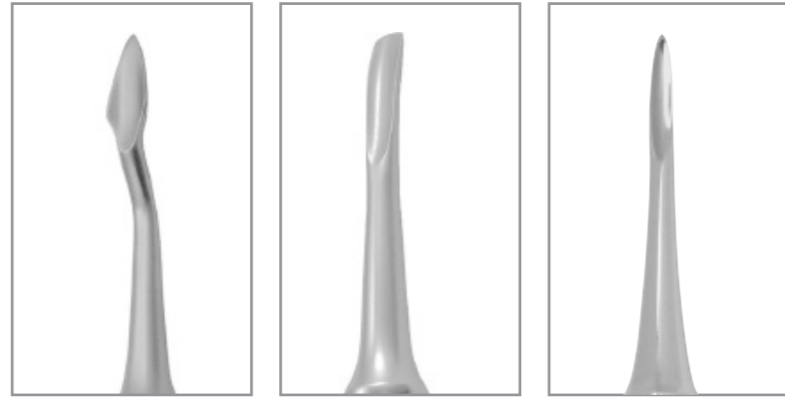

02-720-12 B	02-720-14	02-720-16
Krogh # 12B 155mm	Cryer # 3A 155mm	Cryer # 12 150mm

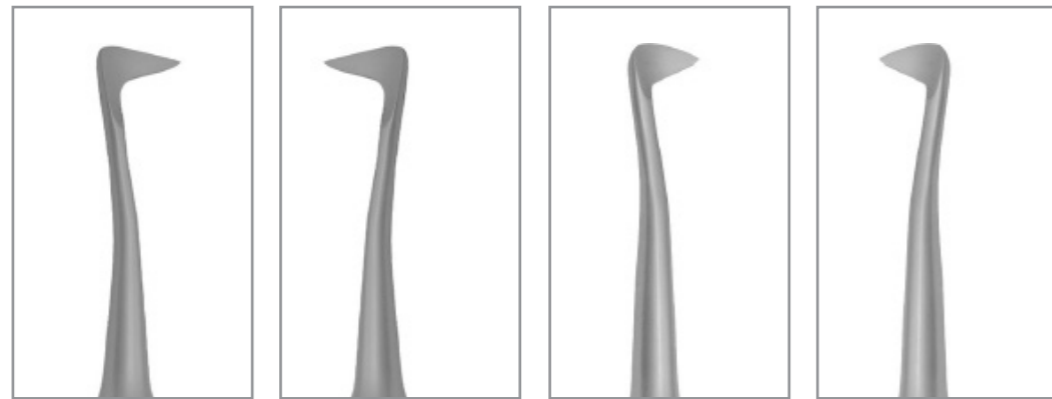

02-720-21	02-720-22	02-720-23	02-720-24
Seldin # 1L 160mm	Seldin # 1R 160mm	Seldin # 4L 160mm	Seldin # 4R 160mm

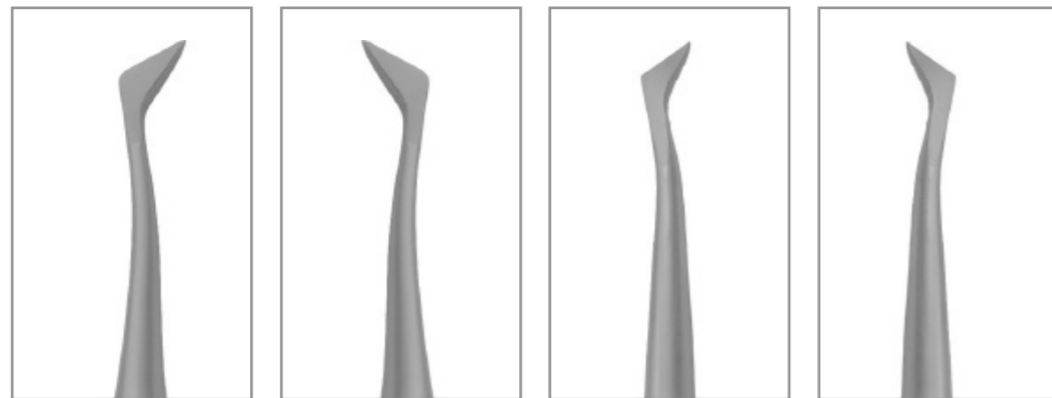

02-720-27	02-720-28	02-720-27 S	02-720-28 S
Cryer # 27 160mm	Cryer # 28 160mm	Cryer # 27S 160mm	Cryer # 28S 160mm



Wurzelheber
Root Elevators
Elévateurs de Racines

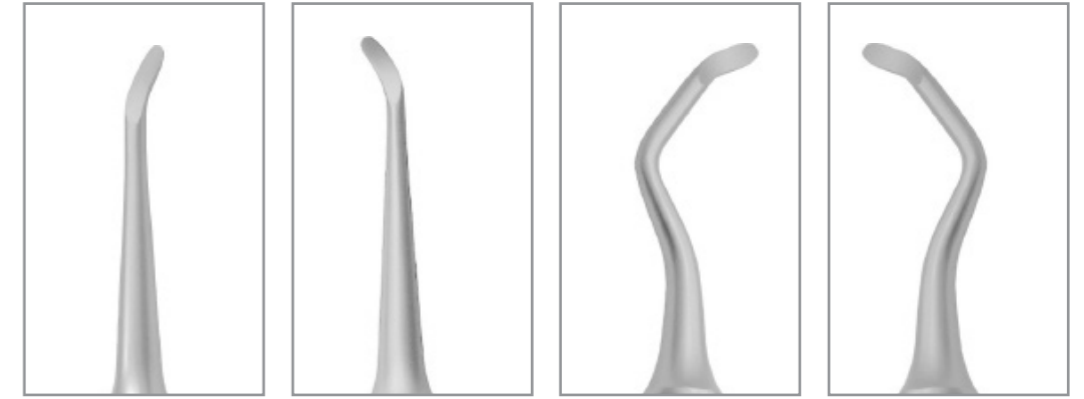

02-720-33	02-720-34	02-720-35	02-720-36
Miller # 1 155mm	Miller # 2 155mm	Miller # 3 155mm	Miller # 4 155mm

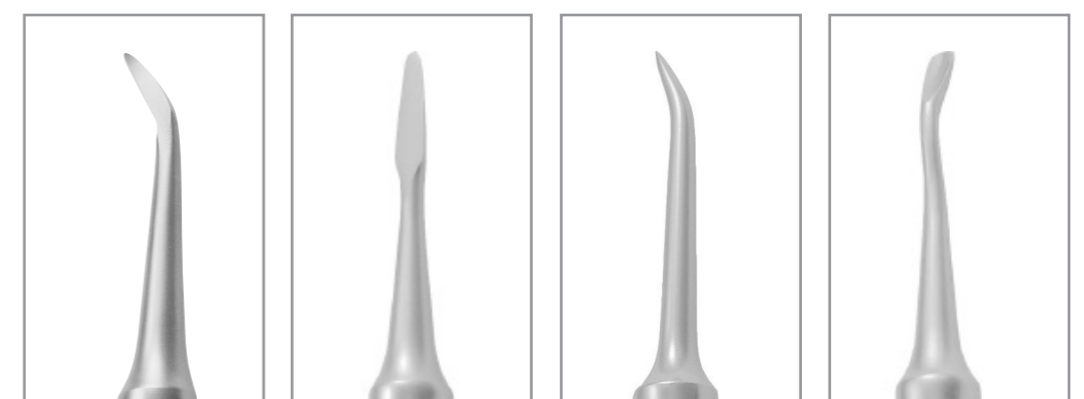

02-720-62	02-720-63	02-720-64	02-720-77 R
Crane Pick # 6 150mm	Cogswell # A 150mm	Cogswell # B 150mm	Glogoff 150mm

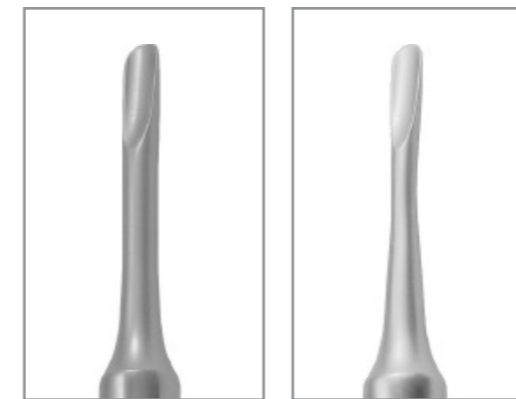

02-720-97	02-720-98
Seldin # 34 150mm	Seldin # 34 S 150mm



Wurzelheber
Root Elevators
Elévateurs de Racines



02-720-290 Apical-Flohr #4 155mm	02-720-291 Apical-Flohr #5 155mm	02-720-293 Apical-Flohr #81 155mm	02-720-295 University of Alabama 150mm
02-720-252 # 46R 150mm	02-725-505 Kratzmann Universal 130mm	02-726-8 Crane-Pick 145mm	02-726-34 S Wolf 145mm
02-720-300 Cameron 155mm	02-735-1 Hylin 4,5 mm 155mm	02-735-2 Hylin 3,0 mm 150mm	02-720-303 Apical-Flohr # 46 150mm

Bernard | Wurzelheber
Bernard | Root elevators
Bernard | Elévateurs de racines



02-60 # 1 4,0 mm 150mm	02-66 # 21 5,0 mm 150mm	02-68 R # 6 4,0 mm 150mm	02-68 L # 7 4,0 mm 150mm
02-60 R 4,0 mm 150mm	02-60 L 4,0 mm 150mm	02-60 B 4,0 mm 160mm	02-60 U 4,0 mm 160mm

Bein | Wurzelheber

Bein | Root elevators
Bein | Elévateurs de racines

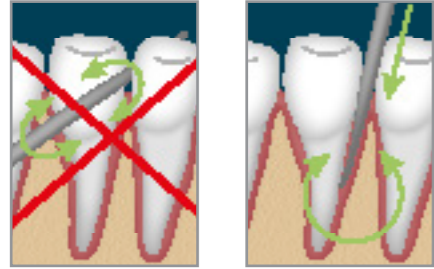

02-680-1
Bein 2,0 mm
140mm



02-680-2
Bein 3,0 mm
140mm



02-680-3
Bein 4,0 mm
140mm



02-680-4
Bein 2,5 mm
135mm

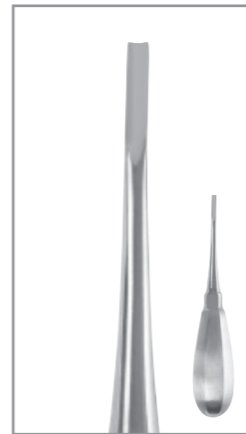

02-680-5
Bein 3,0 mm
135mm



02-680-6
Bein 4,0 mm
140mm



02-725-3
Bein 3,0 mm
140mm

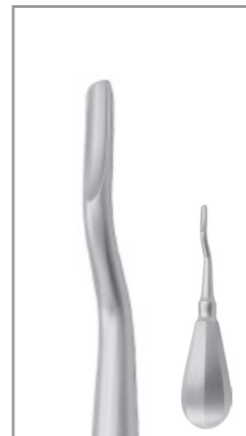

02-725-4
Bein 4,0 mm
140mm



Wurzelheber

Root elevators
Elévateurs de racines



02-1
Bein 3,0 mm
125mm



02-21
Bein 2,5 mm
125mm



02-17
Bein 4,0 mm
125mm

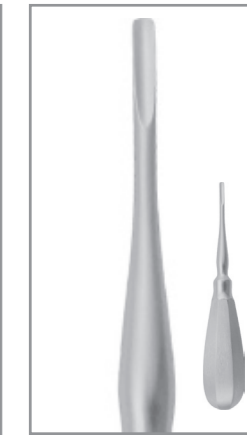

02-65
Bein 3,0 mm
140mm



02-47
3,5 mm
150mm



02-47 U
3,5 mm
150mm



02-52
3,0 mm
150mm



02-69
4,0 mm
160mm

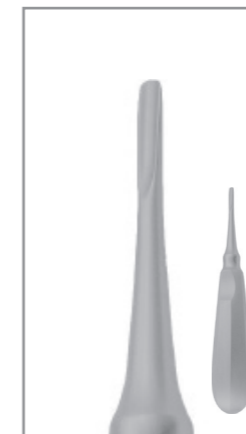

02-53
3,5 mm
150mm

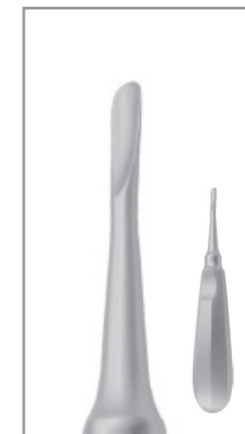

02-54
4,5 mm
150mm



02-720-100
3,5 mm
160mm



Wurzelheber
Root elevators
Elévateurs de racines

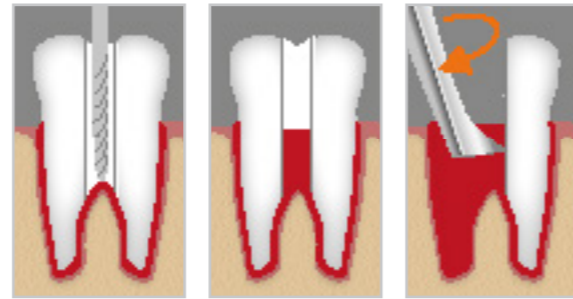

780-1
Barry # 320 120 mm



780-2
Barry # 321 120 mm



775-9
Winter # 14L 125 mm

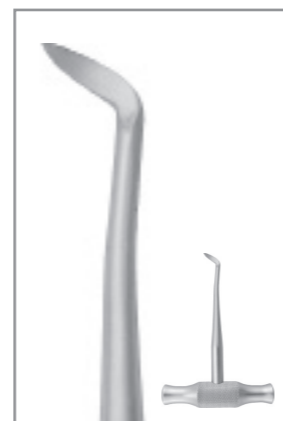

775-10
Winter # 14R 125 mm

Wurzelheber
Root elevators
Elévateurs de racines

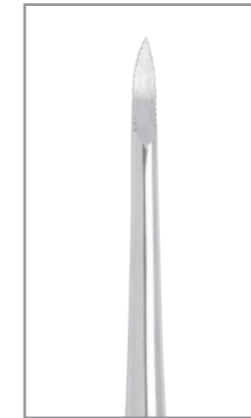

02-24 P
fein gezahnt
fine serrated
dentelurefine 2,5 mm
150mm



02-25 P
fein gezahnt
fine serrated
dentelurefine 2,5 mm
150mm



02-26 P
fein gezahnt
fine serrated
dentelurefine 2,5 mm
150mm

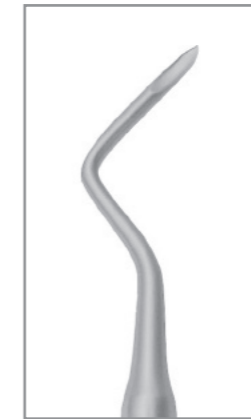

02-25
2,5 mm
150mm

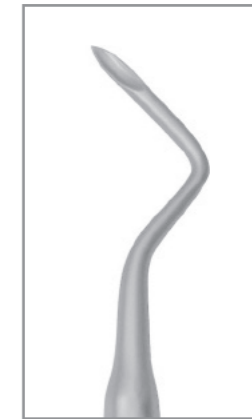

02-26
2,5 mm
150mm



02-790-1
1 Coupland 3,0 mm
145mm



02-790-2
2 Coupland 3,5 mm
150mm



02-790-3
3 Coupland 4,0 mm
150mm

Beck | Wurzelspitzenheber

Beck | Root Fragment Elevators
Beck | Elévateurs de fragments de racines

comfort line

02-792-11 C	comfort line
Beck	171 mm
gezahnt	
serrated	
denteles	

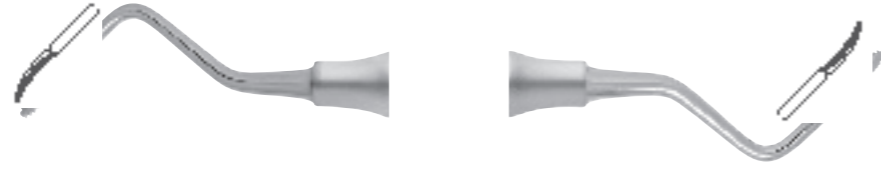

Heidbrink | Wurzelspitzenheber

Heidbrink | Root fragment elevators
Heidbrink | Elévateurs de fragments de racines

02-793-AS-1N	130mm	1,5 mm
02-794-341	140mm	2,2 mm
02-793-AS-1	135mm	2,4 mm
Heidbrink		

gerade
straight
droits



Heidbrink | Wurzelspitzenheber

Heidbrink | Root Fragment Elevators
Heidbrink | Elévateurs de fragments de racines

comfort line

02-792-1 C	comfort line	1,7 mm
02-792-2 C	comfort line	2,1 mm
02-792-3 C	comfort line	2,5 mm
Heidbrink		171 mm

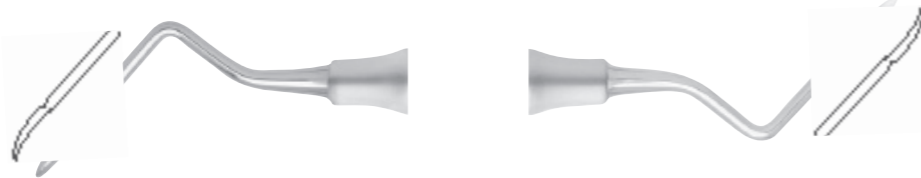

02-793-AS-3N	130mm	1,5 mm
02-794-340	140mm	2,2 mm
02-793-AS-3	135mm	2,4 mm
Heidbrink		

rechts gebogen
curved to the right
courbé à droite



02-792-4 C	comfort line	1,7 mm
02-792-5 C	comfort line	2,1 mm
02-792-6 C	comfort line	2,5 mm
Heidbrink		171 mm



02-793-AS-2N	130mm	1,5 mm
02-794-342	140mm	2,2 mm
02-793-AS-2	135mm	2,4 mm
Heidbrink		

links gebogen
curved to the left
courbé à gauche



Zahnzangen im Überblick

Overview extracting forceps

Résumé de forceps d'extraction

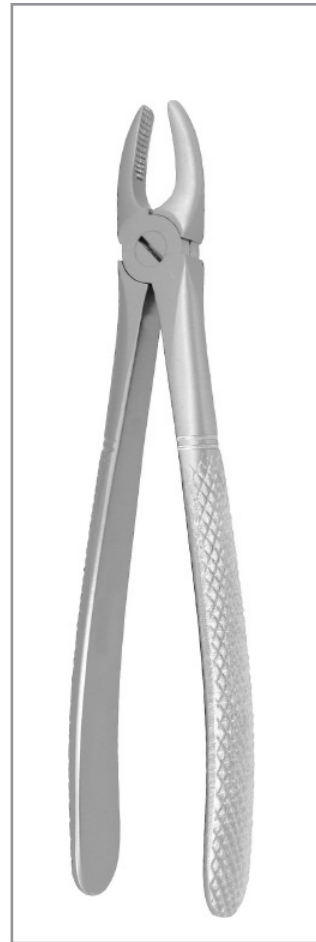

400

- kurzer Griff
- Karogriff
- leicht
- handlich
- Querriefung
- short handle
- serrated handle
- light
- handier
- lateral serrated

- manche court
- manche quadrillé
- léger
- maniable
- rayure transversale



500

- standard
- Karogriff
- Längsriefung
- standard
- serrated handle
- lengthwise serrated
- taille standard
- manche quadrillé
- rayure longitudinale

500 & 650 = same jaw, different handle



650

- standard
- Passformgriff
- Längsriefung
- standard
- fit handle
- lengthwise serrated
- taille standard
- manche anatomique
- rayure longitudinale



1100

- schmales Maul
- Passformgriff
- tiefgreifend
- slim jaw
- fit handle
- more extending
- mors étroits
- manche anatomique
- profond



1200

- Wurzelzangen
- Passformgriff
- Root Forceps
- fit handle
- pour les racines
- manche anatomique



special

- Spezialformen
- Karogriff
- special forms
- serrated handle
- formes spéciales
- manche quadrillé



american

- Amerikanische Formen
- Karogriff
- american forms
- serrated handle
- formes américaines
- manche quadrillé

Zahnzangen | Extract 400 | Oberkiefer

Extracting forceps | Extract 400 | Upper Jaw

Daviers | Extract 400 | Mandibule Supérieure

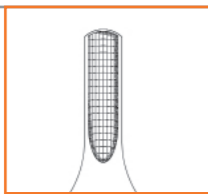

3.2.1, 1.2.3.



3.2.1, 1.2.3.

02-400-2 H		
02-400-2 D		
# 2	160 mm	

Schneide- und Eckzähne
Incisors and cuspids
Incisives et canines

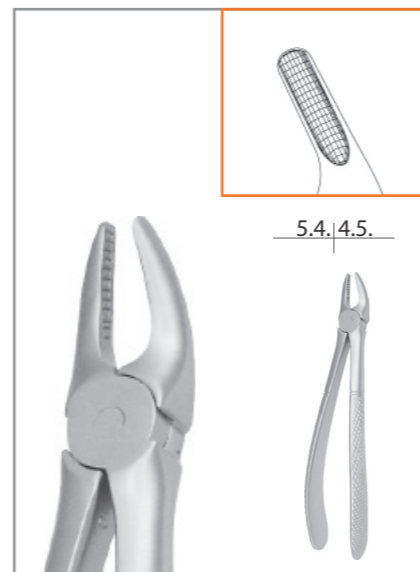

5.4, 4.5.

02-400-7 H		
02-400-7 D		
# 7	160 mm	

Prämolaren
Biscuspids
Prémolaires

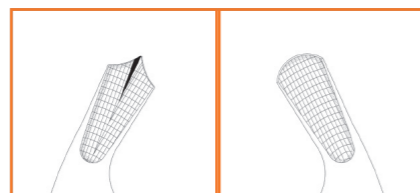
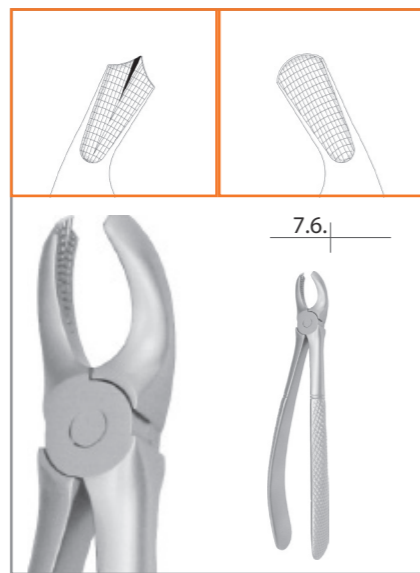

7.6.

02-400-17 H		
02-400-17 D		
# 17	165 mm	

Molaren, rechts
Molars, right
Molaires, droit

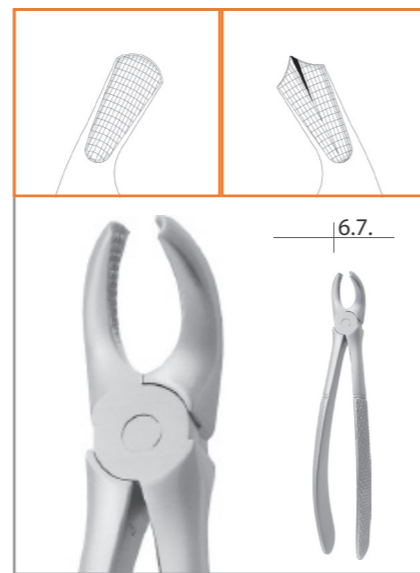

6.7.

02-400-18 H		
02-400-18 D		
# 18	165 mm	

Molaren, links
Molars, left
Molaires, gauche

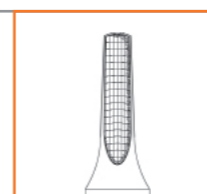
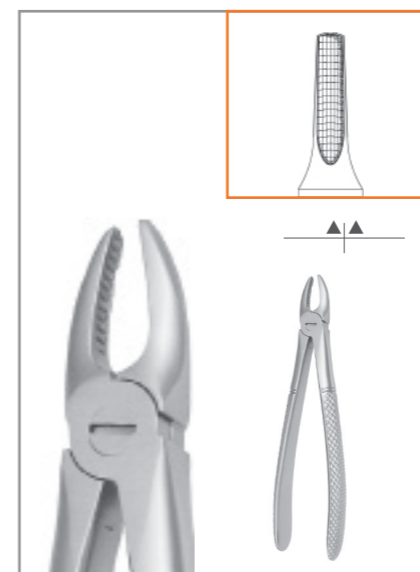

29

02-400-29 H		
02-400-29 D		
# 29	165 mm	

Wurzeln
Roots
Racines

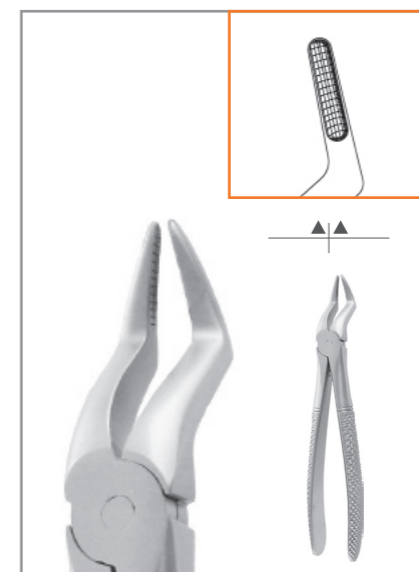

51

02-400-51 AH		
02-400-51 AD		
# 51 A	175 mm	

Wurzeln
Roots
Racines

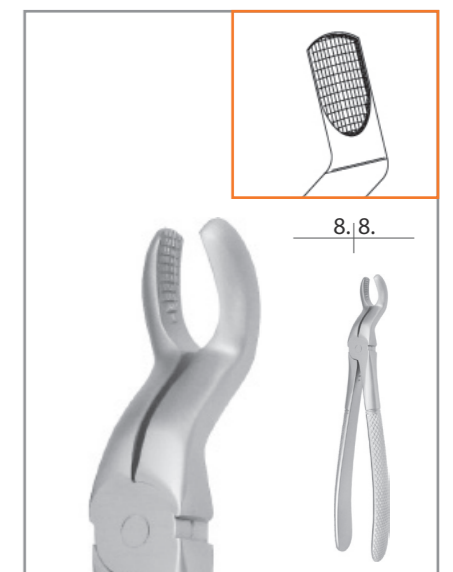

8.8.

02-400-67 H		
02-400-67 D		
# 67	175 mm	

Dritte Molaren
Third molars
Troisièmes molaires

Zahnzangen | Extract 400 | Unterkiefer

Extracting forceps | Extract 400 | Lower Jaw
Daviers | Extract 400 | Mandibule Inférieure



02-400-13 H		
02-400-13 D		
# 13	150 mm	

Prämolaren
Biscuspids
Prémolaires



02-400-22 H		
02-400-22 D		
# 22	140 mm	

Molaren
Molars
Molaires



02-400-73 H		
02-400-73 D		
# 73	150 mm	

Molaren
Molars
Molaires



02-400-33 AH		
02-400-33 AD		
# 33 A	150 mm	

Wurzeln
Roots
Racines



02-400-74 H		
02-400-74 D		
# 74	150 mm	

Schneidezähne und Wurzeln
Incisors and roots
Incisives et racines



02-400-74 NH		
02-400-74 ND		
# 74 N	150 mm	

Schneidezähne und Wurzeln, schlankes Maul
Incisors and roots, with fine jaw
Incisives et racines, avec un bec très fin

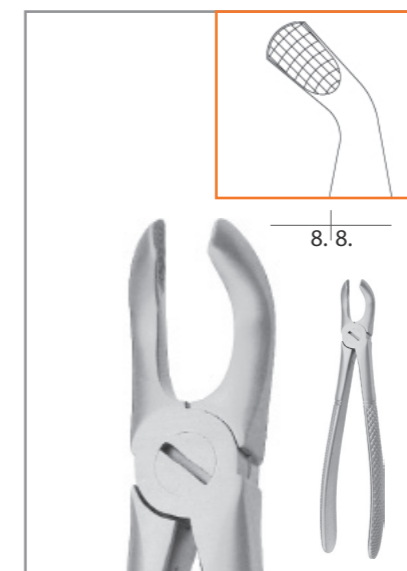

02-400-79 AH		
02-400-79 AD		
# 79 A	165 mm	

Dritte Molaren
Third molars
Troisièmes molaires

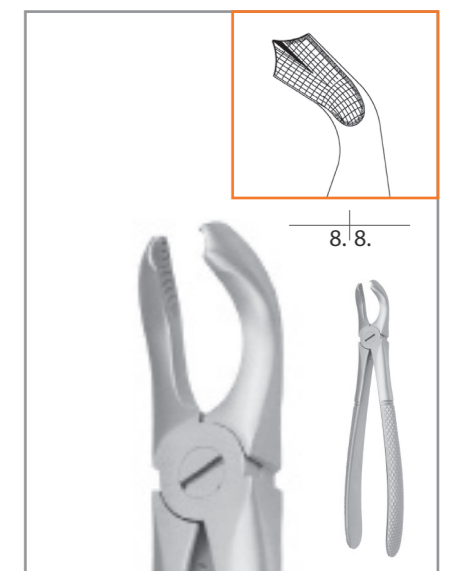

02-400-79 H		
02-400-79 D		
# 79	165 mm	

Dritte Molaren
Third molars
Troisièmes molaires

Zahnzangen | Extract 500 & 650 | Oberkiefer

Extracting forceps | Extract 500 & 650 | Upper Jaw
Daviers | Extract 500 & 650 | Mandibule Supérieure



3.2.1., 1.2.3.



5.4., 4.5.

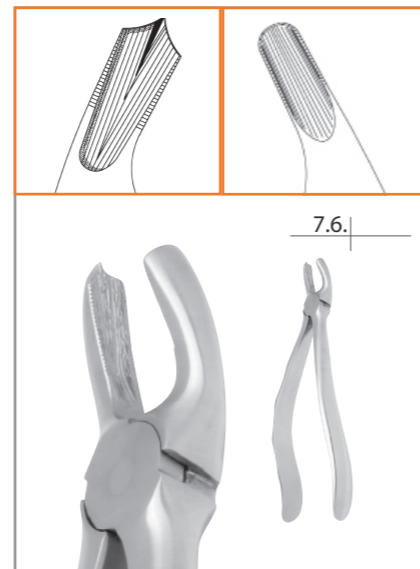

7.6.

02-650-7		
02-500-7		
# 7	160 mm	

Prämolaren
Bicuspidis
Prémolaires

02-650-17		
02-500-17		
# 17	170 mm	

Molaren, rechts
Molars, right
Molaires, droit

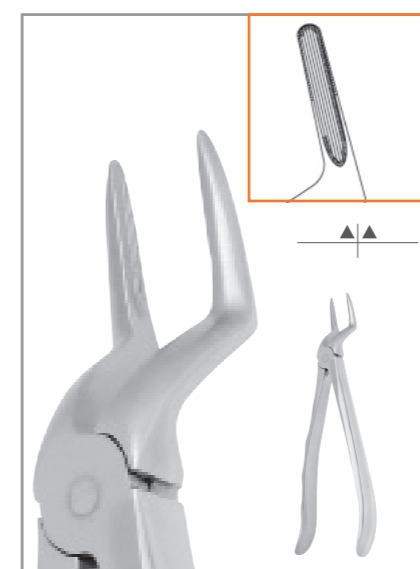

02-650-51 A		
02-500-51 A		
# 51 A	185 mm	

Wurzeln
Roots
Racines

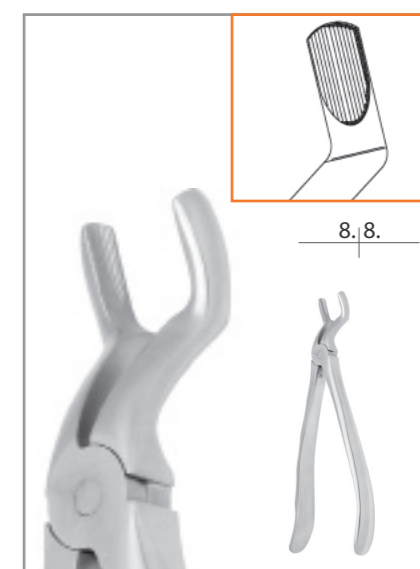

8.8.

02-650-67 A		
02-500-67 A		
# 67 A	170 mm	

Dritte Molaren
Third molars
Troisièmes molaires

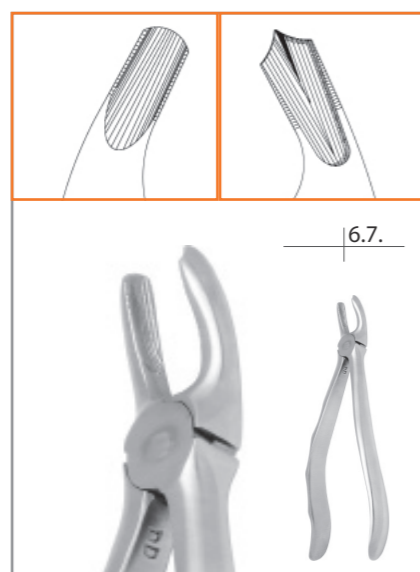

6.7.

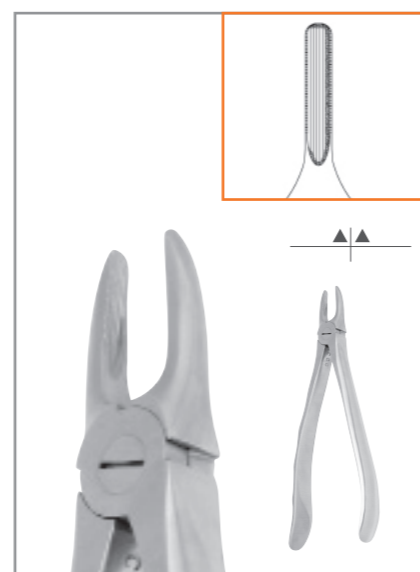

▲▲

02-650-1		
02-500-1		
# 1	170 mm	

Schneide- und Eckzähne
Incisors and cuspids
Incisives et canines

02-650-18		
02-500-18		
# 18	170 mm	

Molaren, links
Molars, left
Molaires, gauche

02-650-29		
02-500-29		
# 29	170 mm	

Wurzeln
Roots
Racines

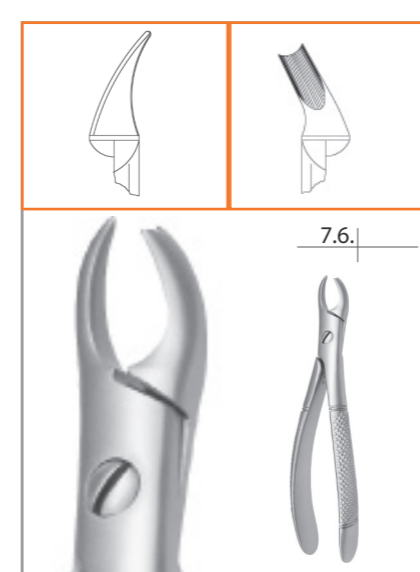

7.6.

02-500-89		
# 89	165 mm	

Molaren, rechts
Molars, right
Molaires, droit

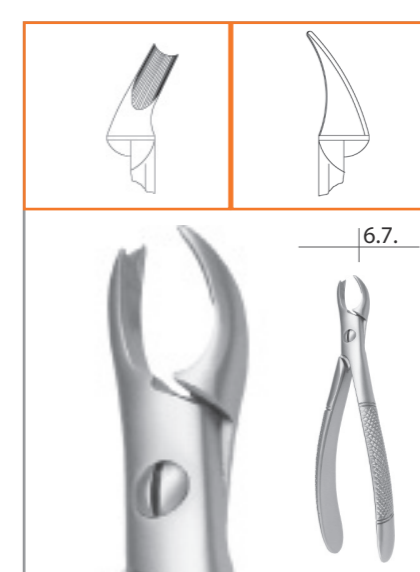

6.7.

02-500-90		
# 90	165 mm	

Molaren, links
Molars, left
Molaires, gauche

Zahnzangen | Extract 500 & 650 | Unterkiefer

Extracting forceps | Extract 500 & 650 | Lower Jaw

Daviers | Extract 500 & 650 | Mandibule Inférieure

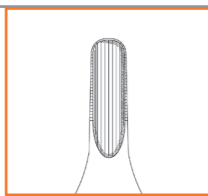

3.2.1.1.2.3.

02-650-4		
02-500-4		
# 4	160 mm	

Schneide- und Eckzähne
Incisors and cuspids
Incisives et canines



5.4.4.5.

02-650-8		
02-500-8		
# 8	160 mm	

Prämolaren
Biscuspids
Prémolaires



5.4.4.5.

02-650-13		
02-500-13		
# 13	155 mm	

Prämolaren
Biscuspids
Prémolaires



7.6.6.7.

02-650-22		
02-500-22		
# 22	155 mm	

Molaren
Molars
Molaires

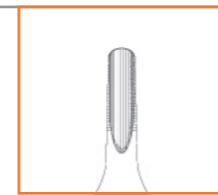

2.1.1.2.

02-650-33 A		
02-500-33 A		
# 33 A	155 mm	

Wurzeln
Roots
Racines

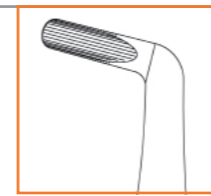
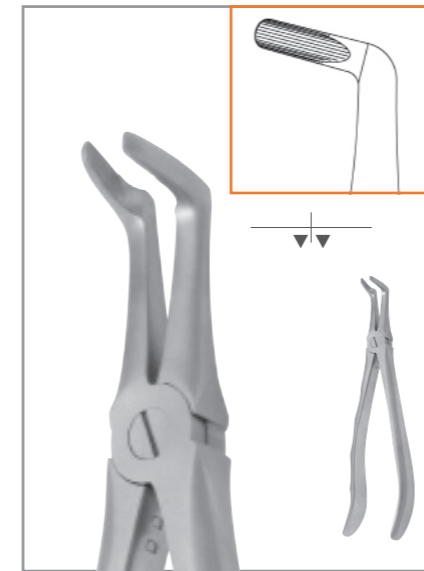

7.6.6.7.

02-650-45		
02-500-45		
# 45	175 mm	

Wurzeln
Roots
Racines

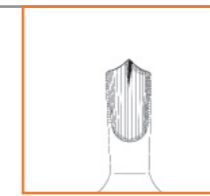

7.6.6.7.

02-650-73		
02-500-73		
# 73	155 mm	

Molaren
Molars
Molaires

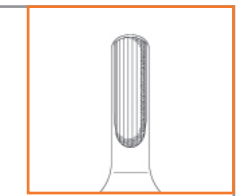
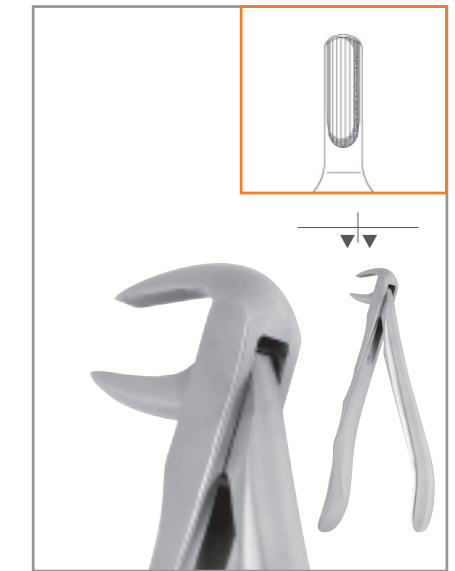

7.6.6.7.

02-650-74		
02-500-74		
# 74	150 mm	

Wurzeln
Roots
Racines



2.1.1.2.

02-650-74 XN		
02-500-74 XN		
# 74 XN	150 mm	

Schneidezähne und Wurzeln
Incisors and roots
Incisives et racines



8.8.

02-650-79		
02-500-79		
# 79	170 mm	

Dritte Molaren
Third molars
Troisièmes molaires

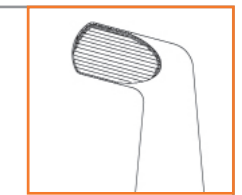
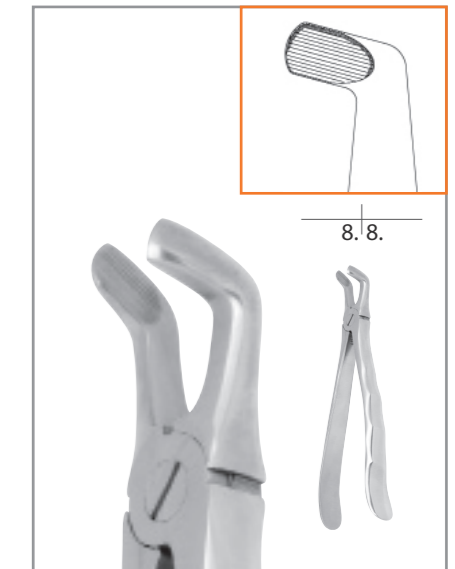

8.8.

02-650-79 A		
02-500-79 A		
# 79 A	170 mm	

Dritte Molaren
Third molars
Troisièmes molaires

Zahnzangen | Extract 1100 | Oberkiefer

Extracting forceps | Extract 1100 | Upper Jaw
Daviers | Extract 1100 | Mandibule Supérieure



3.2.1. | 1.2.3.

02-1101 P		
02-1101		
# 1	170 mm	
Schneide- und Eckzähne Incisors and cuspids Incisives et canines		

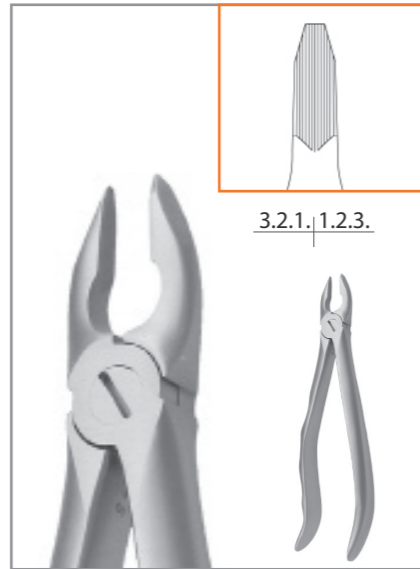

3.2.1. | 1.2.3.

02-1102 P		
02-1102		
02-1102 D		
# 2	165 mm	
Schneide- und Eckzähne Incisors and cuspids Incisives et canines		

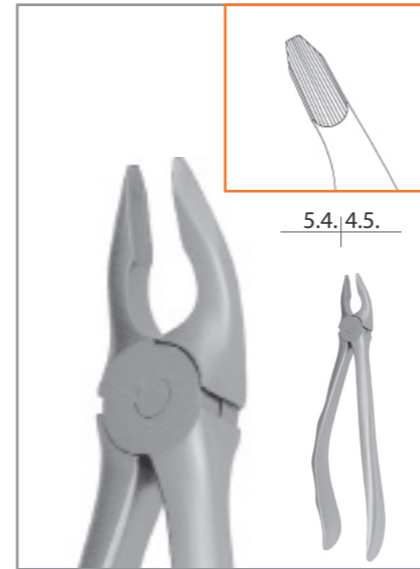

5.4. | 4.5.

02-1107 P		
02-1107		
02-1107 D		
# 7	170 mm	
Prämolaren Biscuspids Prémolaires		

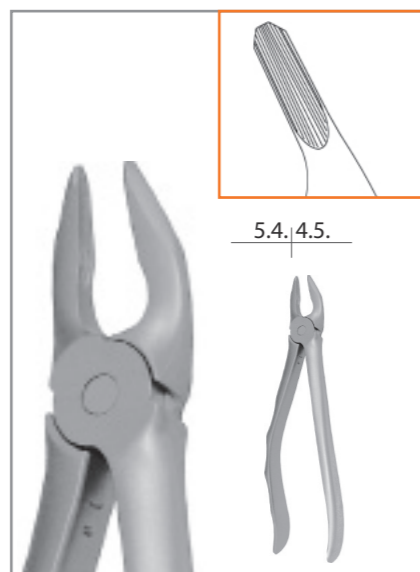

5.4. | 4.5.

02-1107 NP		
02-1107 N		
# 7 N	165 mm	
Prämolaren Biscuspids Prémolaires		

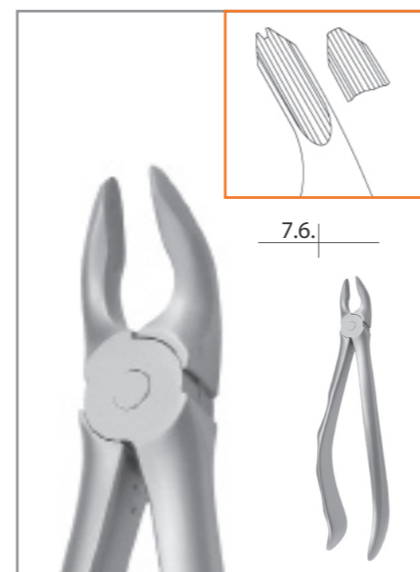

7.6. |

02-1117 P		
02-1117		
# 17	170 mm	
Molaren, rechts Molars, right Molaires, droit		

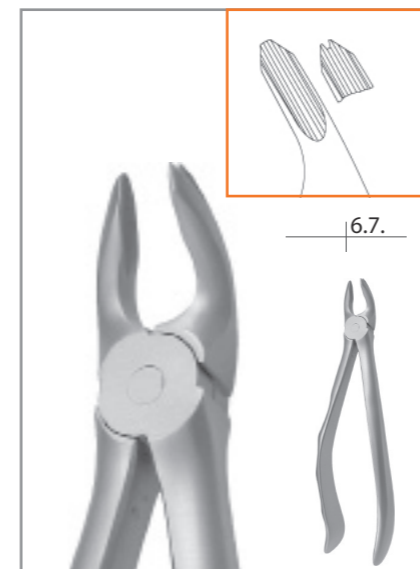

6.7. |

02-1118 P		
02-1118		
# 18	170 mm	
Molaren, links Molars, left Molaires, gauche		

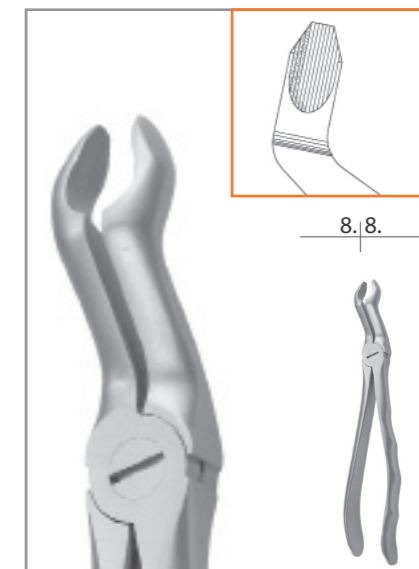

8.8. |

02-1167 P		
02-1167		
# 67	180 mm	
Dritte Molaren Third molars Troisièmes molaires		

Zahnzangen | Extract 1100 | Unterkiefer

Extracting forceps | Extract 1100 | Lower Jaw
Daviers | Extract 1100 | Mandibule Inférieure



02-1108 P		
02-1108		
# 8	170 mm	
Prämolaren Bicuspidis Prémolaires		

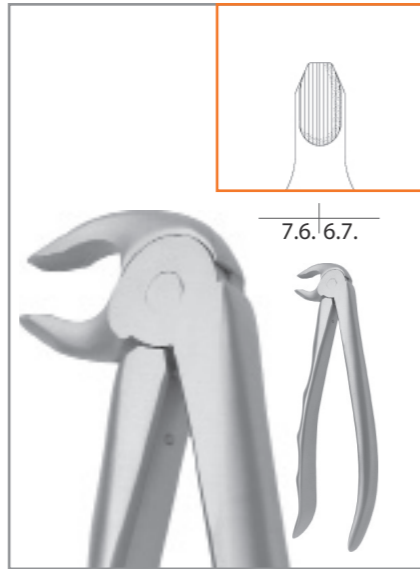

02-1122 P		
02-1122 K		
# 22	155 mm	
Molaren Molars Molaires		

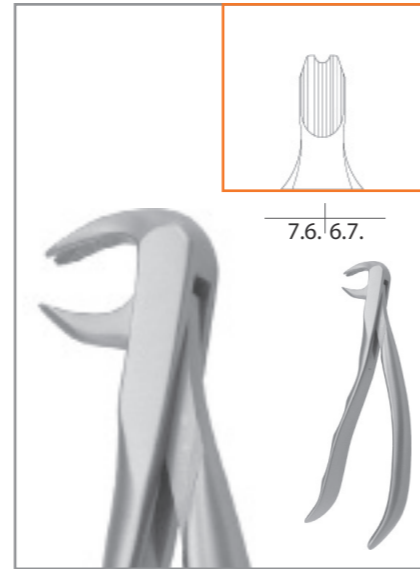

02-1173 P		
02-1173 K		
# 73	145 mm	
Molaren Molars Molaires		

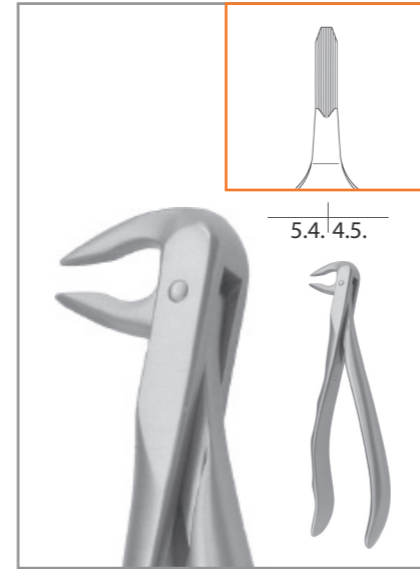

02-1174 XNP		
02-1174 XN		
# 74 XN	145 mm 3,0 mm	
Prämolaren Bicuspidis Prémolaires		

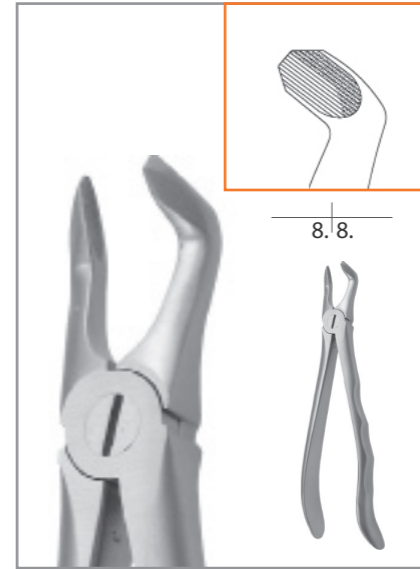

02-1179 AP		
02-1179 A		
# 79 A	175 mm	
Dritte Molaren Third molars Troisièmes molaires		

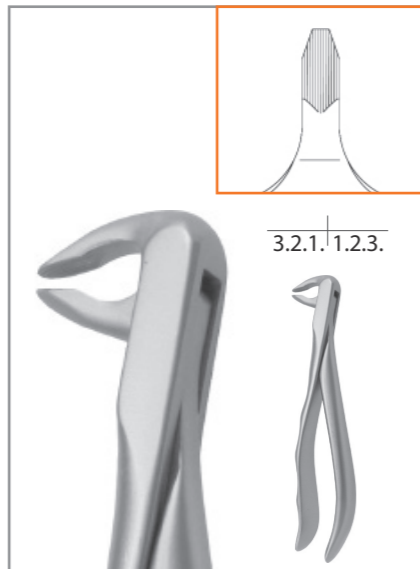

02-1174 P		
02-1174		
02-1174 D		
# 74	145 mm	
Schneide- und Eckzähne Incisors and cuspids Incisives et canines		

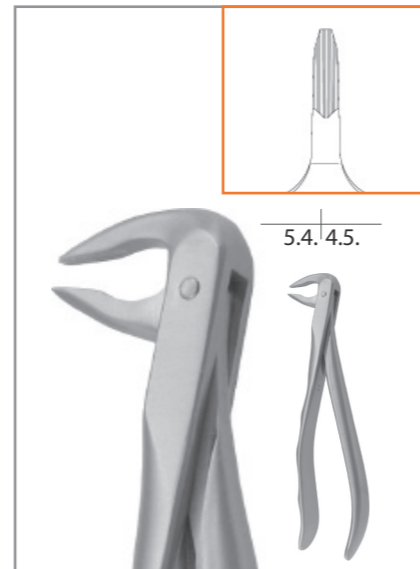

02-1174 NP		
02-1174 N		
# 74 N	145 mm 4,0 mm	
Prämolaren Bicuspidis Prémolaires		

Zahnzangen | Extract 1200 | Oberkiefer

Extracting forceps | Extract 1200 | Upper Jaw
Daviers | Extract 1200 | Mandibule Supérieure

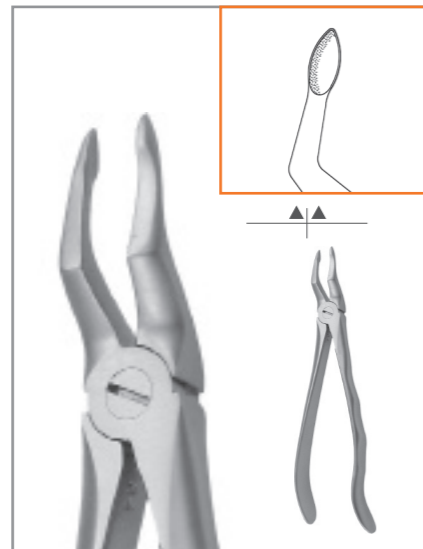

02-1251 EP	
02-1251 E	
02-1251 EPS	
02-1251 ES	
# 51 E	165 mm
Wurzeln Roots Racines	

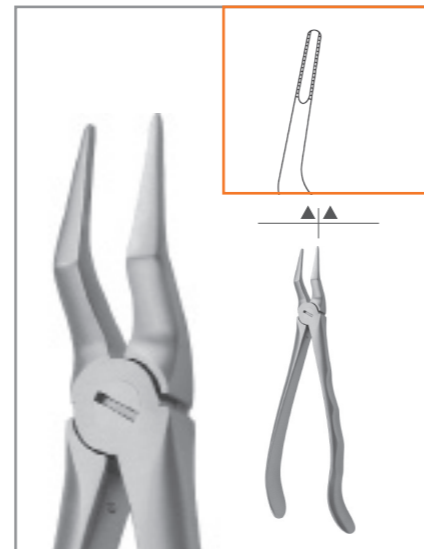

02-1251 NP	
02-1251 N	
02-1251 ND	
# 51 N	165 mm
Wurzeln Roots Racines	

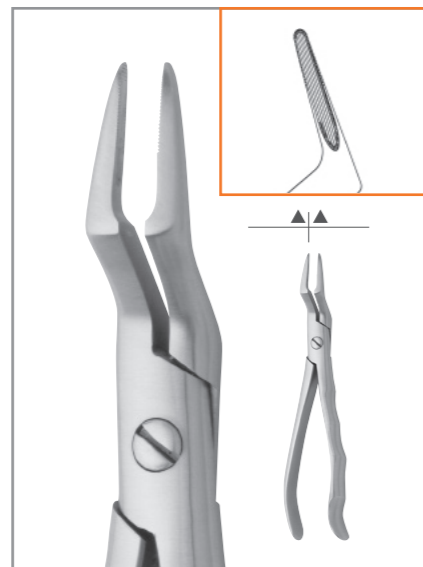

02-1229 EP	
02-1229 E	
02-1229 EPS	
02-1229 ES	
# 29 E	165 mm
Wurzeln Roots Racines	

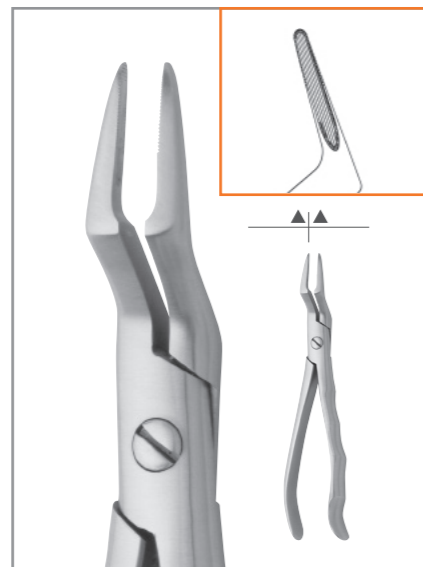

02-1296 P	
# 96	175 mm
Wurzeln Roots Racines	

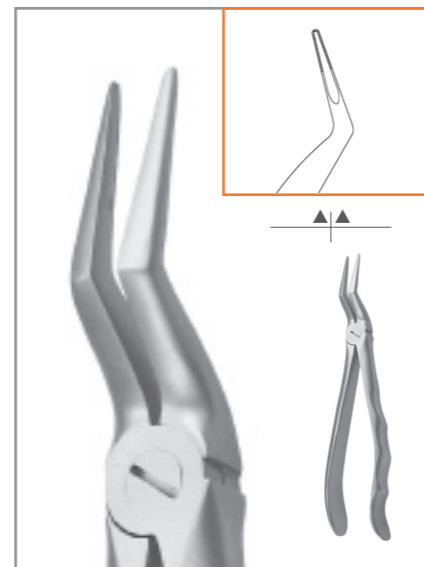

02-1296 AP	
02-1296 A	
# 96 A	195 mm
Wurzeln Roots Racines	

Zahnzangen | Extract 1200 | Unterkiefer

Extracting forceps | Extract 1200 | Lower Jaw
Daviers | Extract 1200 | Mandibule Inférieure

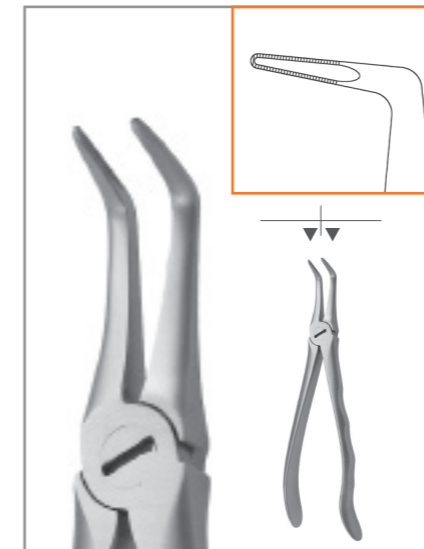

02-1245 P	
02-1245	
02-1245 D	
# 45	170 mm
Wurzeln Roots Racines	

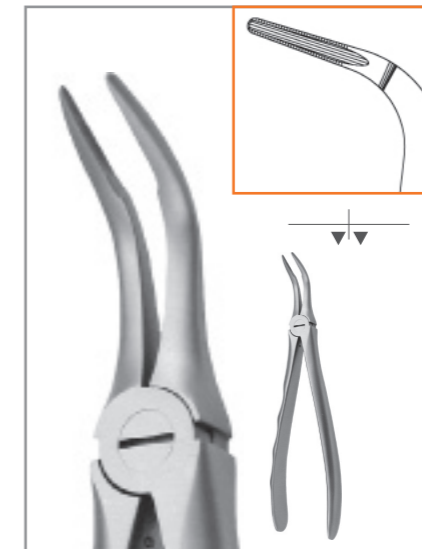

02-1246 P	
# 46	185 mm
Wurzeln Roots Racines	

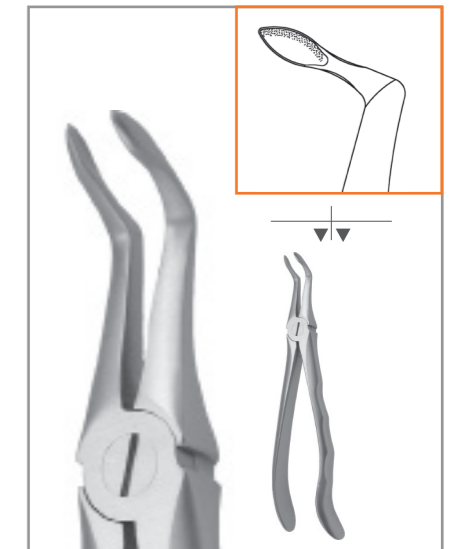

02-1249 P	
02-1249	
02-1249 PS	
02-1249 S	
# 49	165 mm
Wurzeln Roots Racines	

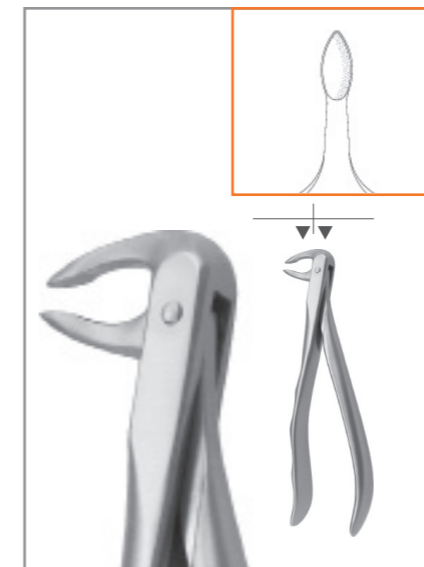

02-1274 EP	
02-1274 E	
02-1274 EPS	
02-1274 ES	
# 74 E	150 mm
Wurzeln Roots Racines	

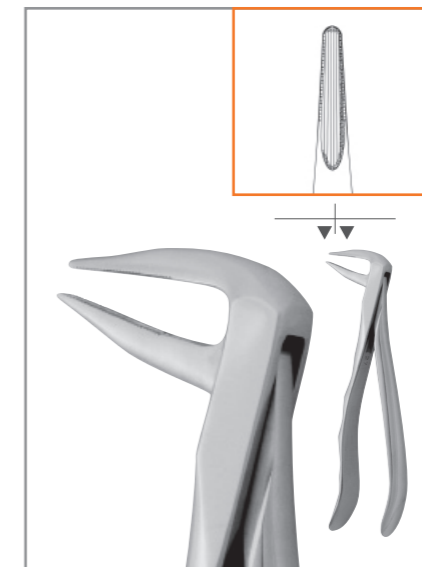

02-1290 ABP	
# 90 AB	150 mm
Wurzeln Roots Racines	

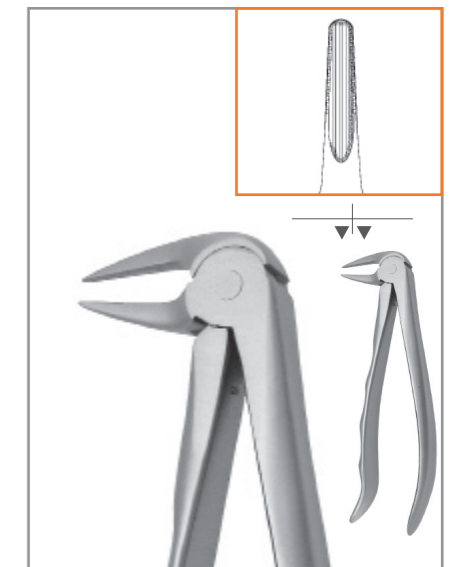

02-1290 AP	
02-1290 A	
# 90 A	150 mm
Wurzeln Roots Racines	

Zahnzangen | Special-Extract | Oberkiefer

Extracting forceps | Special Extract | Upper Jaw
Daviers | Special Extract | Mandibule Supérieure



02-111 P
special 170 mm
Schneide- und Eckzähne
Incisors and cuspids
Incisives et canines

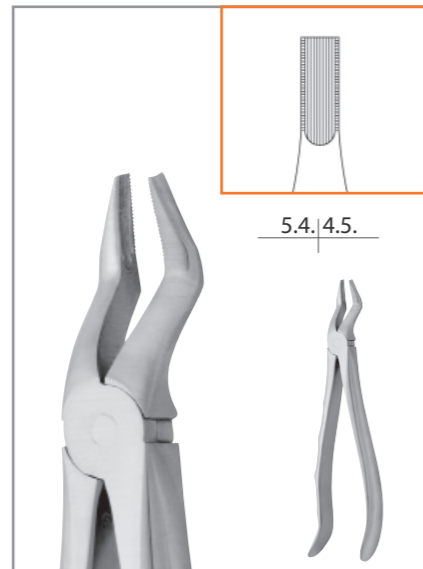

02-1251 BP
special | # 51 B 155 mm
Prämolaren
Biscuspids
Prémolaires

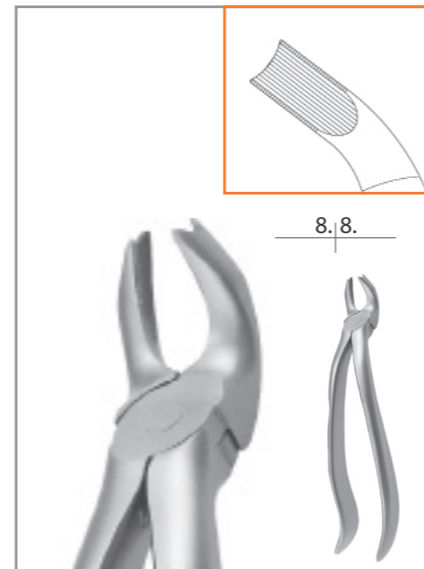

02-1219 P
02-1219
special 160 mm
Dritte Molaren
Third molars
Troisièmes molaires

Zahnzangen | Special-Extract | Oberkiefer

Extracting forceps | Special Extract | Upper Jaw
Daviers | Special Extract | Mandibule Supérieure

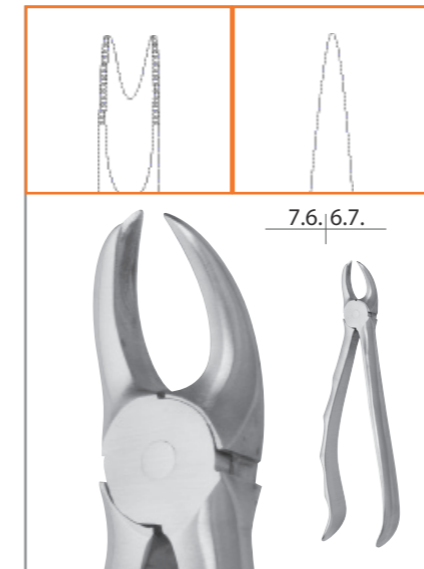

02-1266 HLP
66 HL 160 mm
Molaren
Molars
Molaires

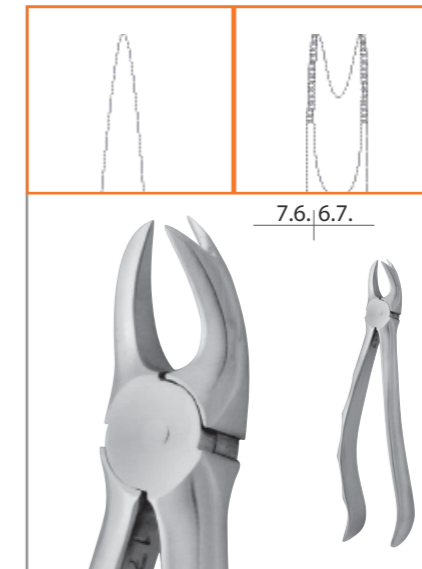

02-1266 HRP
66 HR 160 mm
Molaren
Molars
Molaires

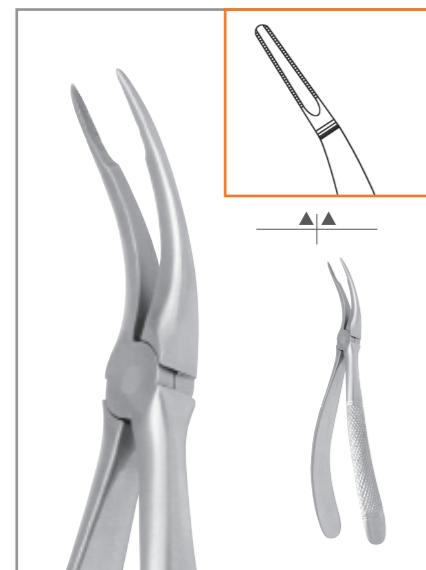

02-144 SP
02-144 S
special 185 mm
Wurzeln
Roots
Racines

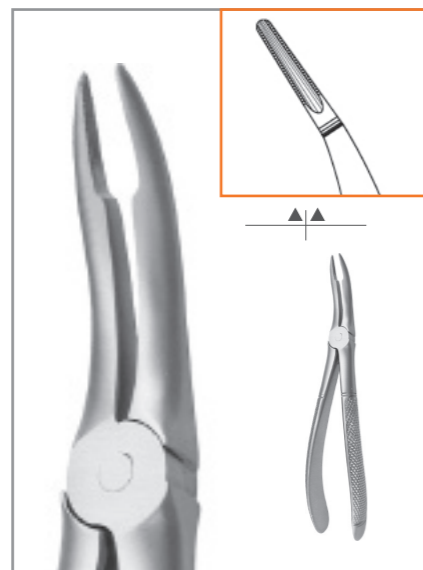

02-144 P
02-144
special 185 mm
Wurzeln
Roots
Racines

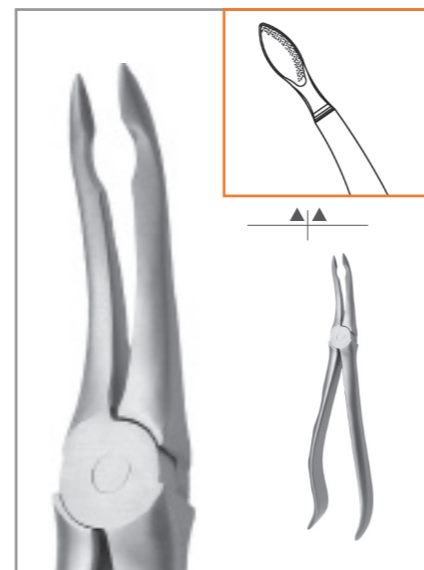

02-144 EP
02-144 E
02-144 EPS
02-144 ES
special 190 mm
Wurzeln
Roots
Racines

Zahnzangen | Special-Extract | Unterkiefer

Extracting forceps | Special Extract | Lower Jaw
Daviers | Special Extract | Mandibule Inférieure

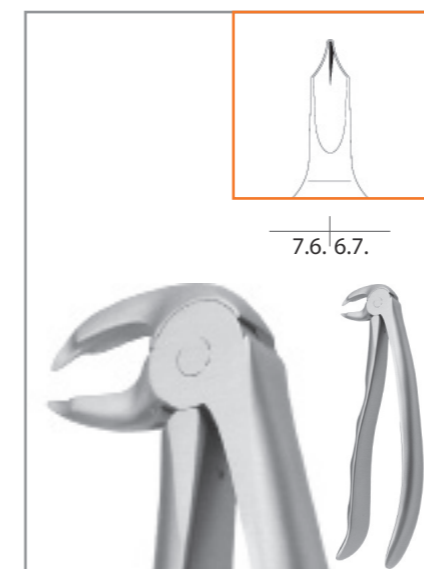

02-522 P
special 150 mm
Molaren
Molars
Molaires



02-586 P
02-586
special 150 mm
Molaren
Molars
Molaires

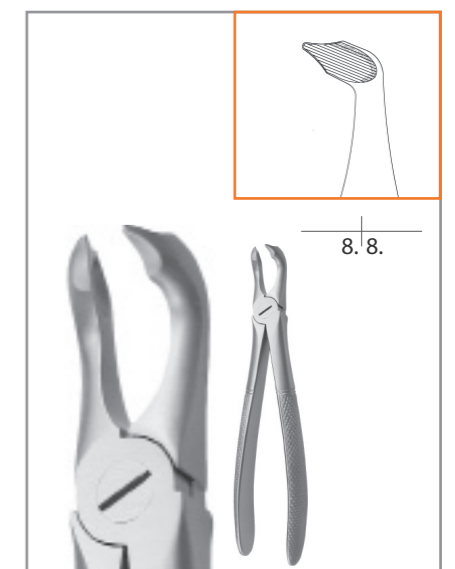

02-79 AS
special 170 mm
Dritte Molaren
Third molars
Troisièmes molaires

Zahnzangen | Special-Extract | Unterkiefer

Extracting forceps | Special Extract | Lower Jaw
Daviers | Special Extract | Mandibule Inférieure



02-22 1-2 LP		
02-22 1-2 L		
# special	180 mm	
Molaren und dritte Molaren Molars and third molars Molaires et troisièmes molaires		



02-22 1-2 RP		
02-22 1-2 R		
# special	180 mm	
Molaren und dritte Molaren Molars and third molars Molaires et troisièmes molaires		

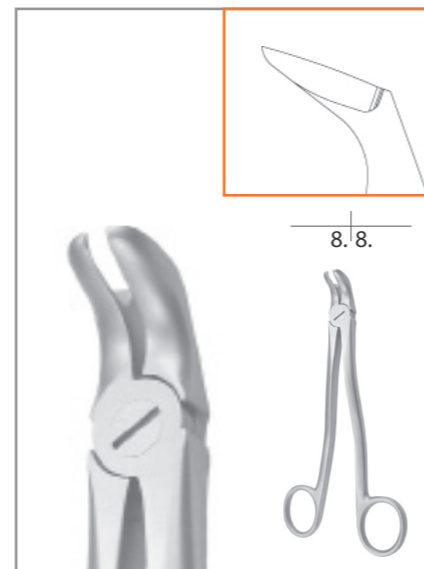

02-602 P		
# special	170 mm	
Dritte Molaren Third molars Troisièmes molaires		

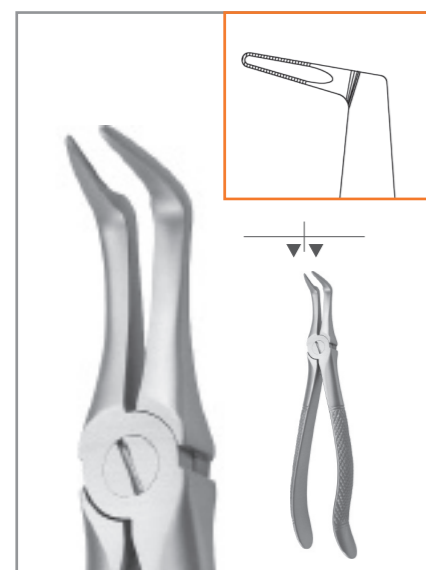

02-145		
# special	170 mm	
Wurzeln Roots Racines		

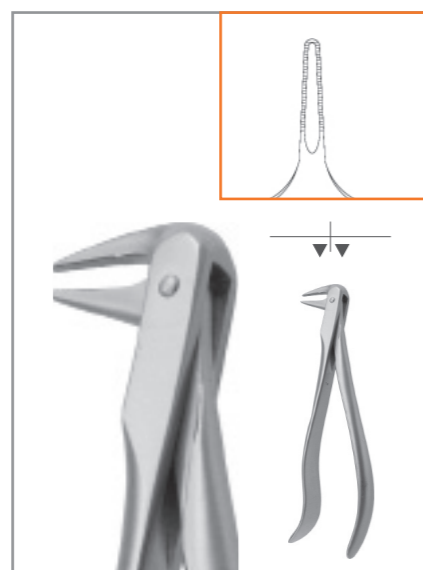

02-605 P		
02-605 D		
# special	140 mm	
Wurzeln Roots Racines		



02-606 D		
# special	140 mm	
Wurzeln Roots Racines		

Zahnzangen | American-Extract | Oberkiefer

Extracting forceps | American-Extract | Upper Jaw
Daviers | American-Extract | Mandibule Supérieure

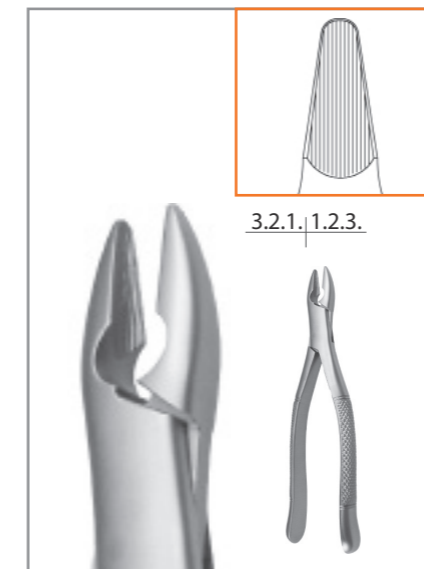

02-600-W-1		
# 1 Winter	190 mm	
Schneide- und Eckzähne Incisors and cuspids Incisives et canines		

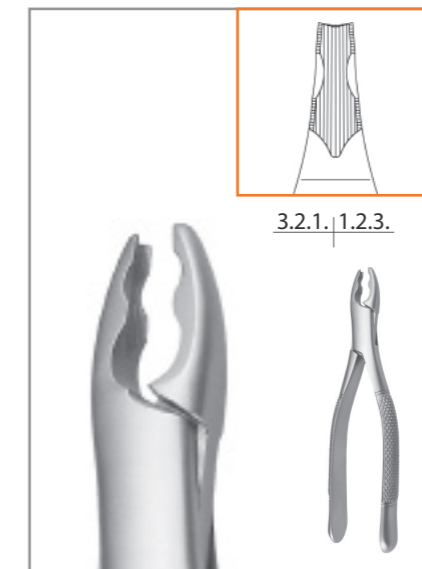

02-600-1 AS		
# 1 AS	175 mm	
Schneide- und Eckzähne Incisors and cuspids Incisives et canines		

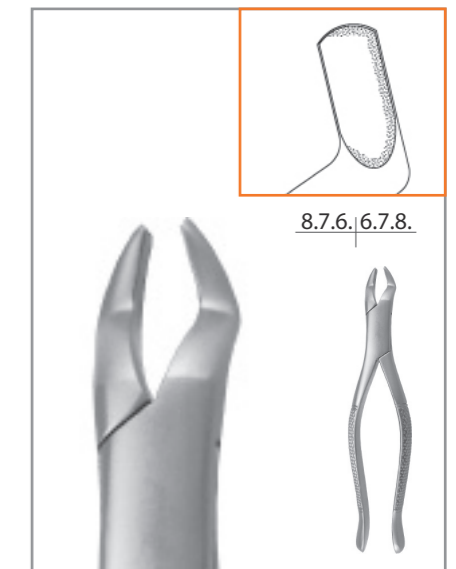

02-600-10 S		
# 10 S	180 mm	
Molaren und dritte Molaren Molars and third molars Molaires et troisièmes molaires		

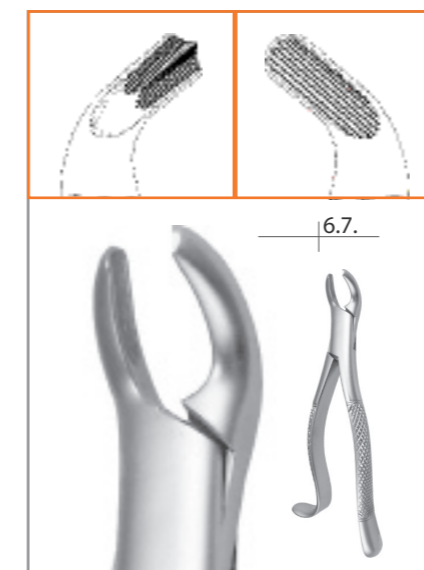

02-600-18 L		
# 18 L	170 mm	
Molaren, links Molars, left Molaires, gauche		



02-600-18 R		
# 18 R	170 mm	
Molaren, rechts Molars, right Molaires, droit		



02-600-32		
# 32 Parmly	190 mm	
Molaren, Prämolaren und Wurzeln Molars, Bicuspid and roots Molaires, Prémolaires et racines		

Zahnzangen | American-Extract | Oberkiefer

Extracting forceps | American-Extract | Upper Jaw
Daviers | American-Extract | Mandibule Supérieure

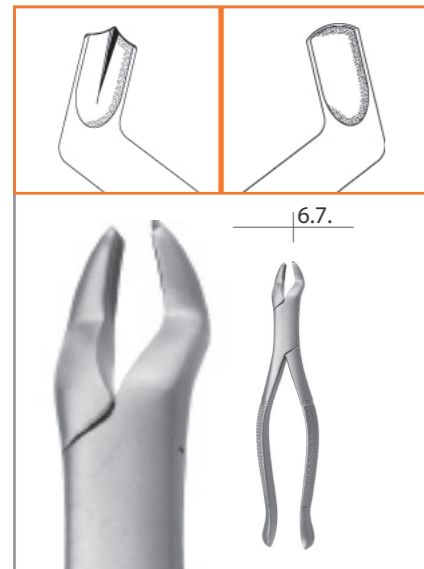

02-600-53 L
53 L 180 mm
Molaren, links
Molars, left
Molaires, gauche

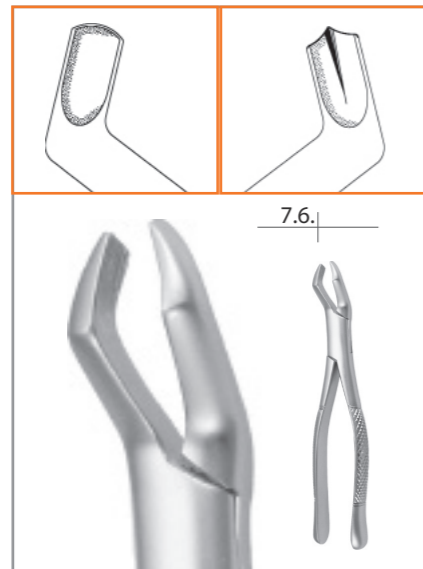

02-600-53 R
53 R 180 mm
Molaren, rechts
Molars, right
Molaires, droit



02-600-65
65 190 mm
Schneidezähne und Wurzeln
Incisors and roots
Incisives et racines

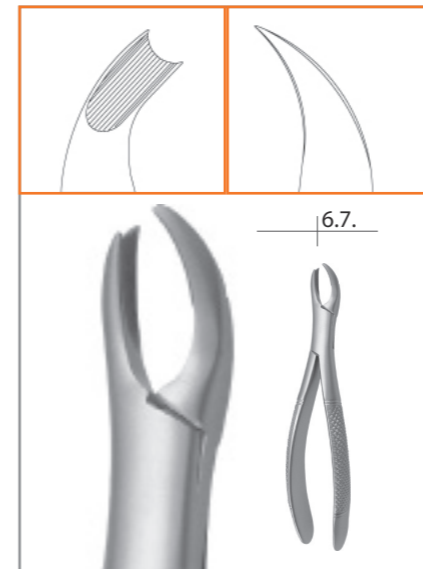

02-635-90
90 170 mm
Molaren, links
Molars, left
Molaires, gauche



02-600-150 LR
02-600-150
02-600-150 D
150 Cryer 180 mm
Prämolaren, Schneidezähne und Wurzeln
Bicuspidis, incisors and roots
Prémolaires, incisives et racines

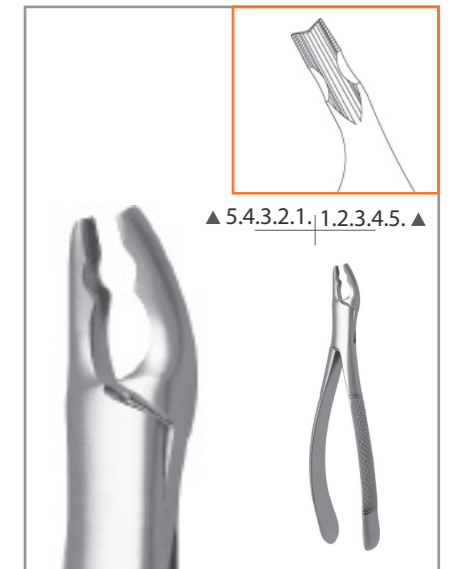

02-600-150 AB
150 AB 180 mm
Prämolaren, Schneidezähne und Wurzeln
Bicuspidis, incisors and roots
Prémolaires, incisives et racines

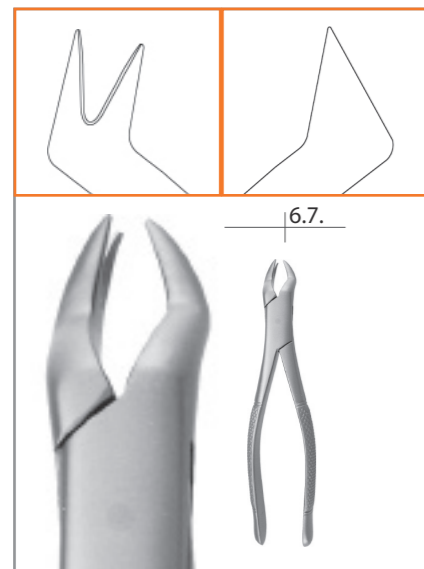

02-600-88 L
88 L Nevius 185 mm
Molaren, links
Molars, left
Molaires, gauche

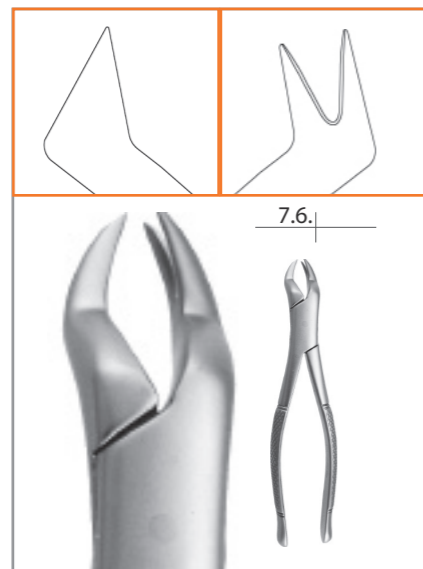

02-600-88 R
88 R Nevius 185 mm
Molaren, rechts
Molars, right
Molaires, droit

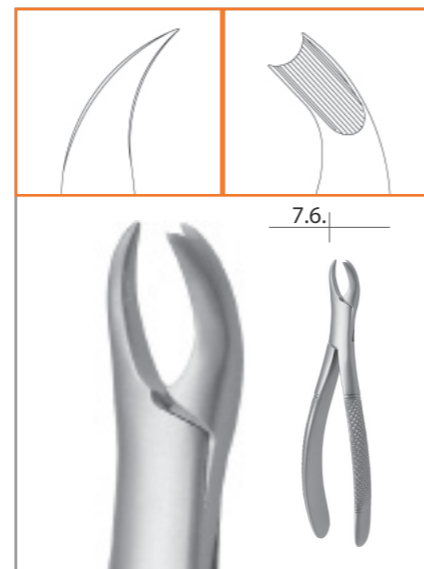

02-635-89
89 170 mm
Molaren, rechts
Molars, right
Molaires, droit

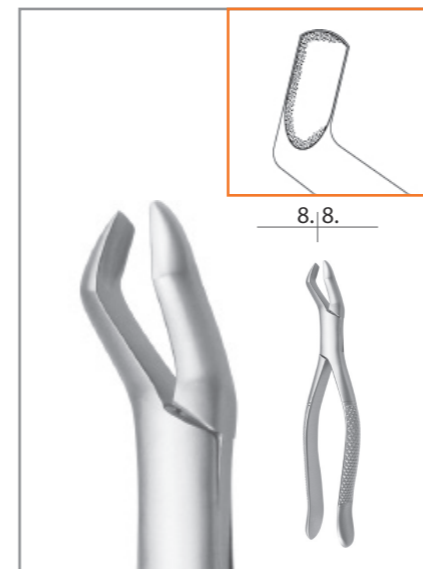

02-600-210 S
210 S 180 mm
Dritte Molaren
Third molars
Troisièmes molaires



02-600-273
02-600-273 D
273 180 mm
Prämolaren, Schneidezähne und Wurzeln
Bicuspidis, incisors and roots
Prémolaires, incisives et racines

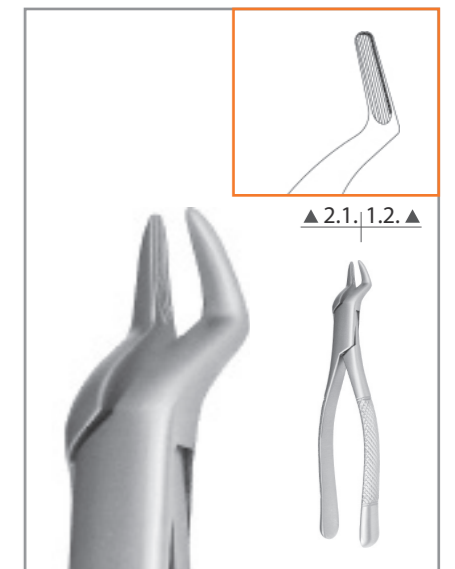

02-600-286
02-600-286 D
286 180 mm
Schneidezähne und Wurzeln
Incisors and roots
Incisives et racines

Zahnzangen | American-Extract | Unterkiefer

Extracting forceps | American-Extract | Lower Jaw

Daviers | American-Extract | Mandibule Inférieure

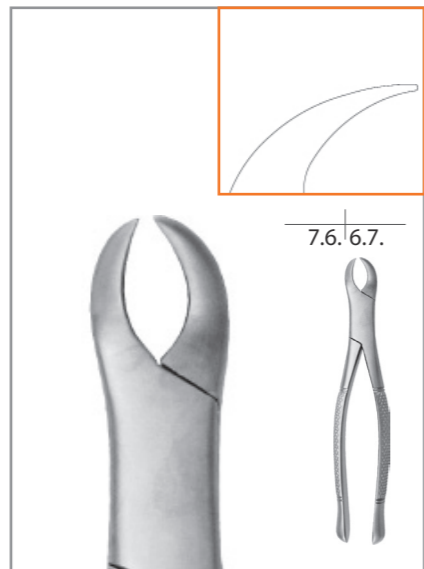

02-600-23
23 165 mm
Molaren
Molars
Molaires



02-600-151 LR
02-600-151
02-600-151 D
151 Cryer 170 mm
Prämolaren, Schneidezähne und Wurzeln
Bicuspid, incisors and roots
Prémolaires, incisives et racines

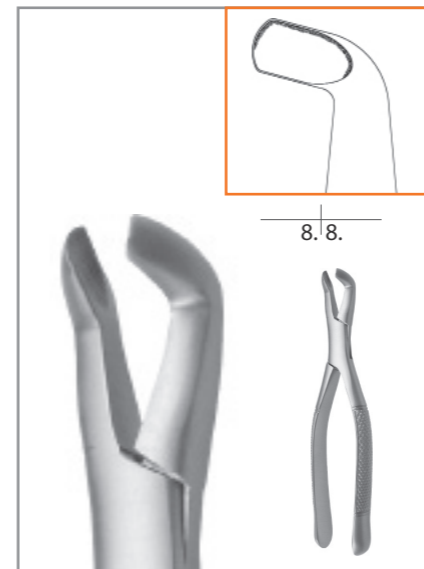

02-600-222
222 180 mm
Dritte Molaren
Third molars
Troisièmes molaires

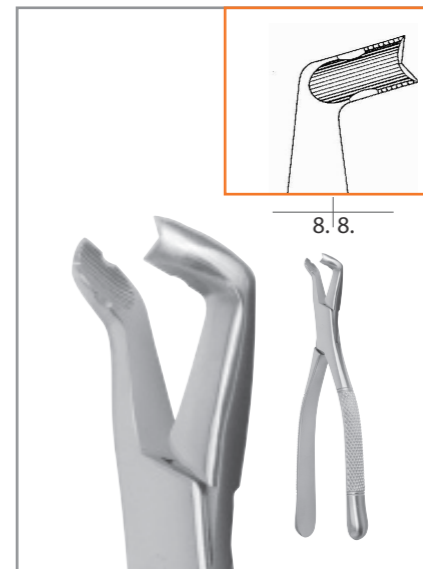

02-600-222 AS
222 AS 180 mm
Dritte Molaren
Third molars
Troisièmes molaires

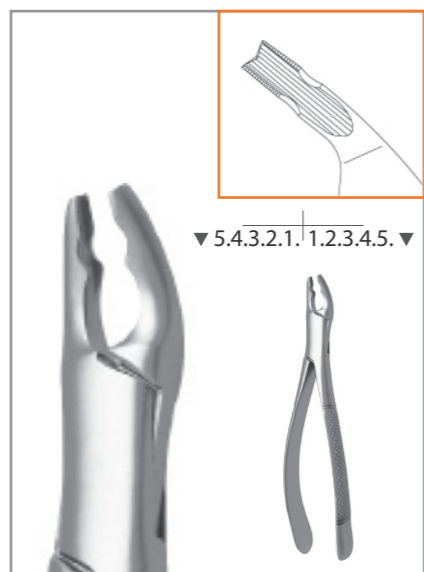

02-600-151 AB
151 AB 170 mm
Prämolaren, Schneidezähne und Wurzeln
Bicuspid, incisors and roots
Prémolaires, incisives et racines



02-600-217
217 170 mm
Dritte Molaren
Third molars
Troisièmes molaires



02-600-274
02-600-274 D
274 170 mm
Prämolaren, Schneidezähne und Wurzeln
Bicuspid, incisors and roots
Prémolaires, incisives et racines



02-600-274 N
274 N 170 mm
Prämolaren, Schneidezähne und Wurzeln
Bicuspid, incisors and roots
Prémolaires, incisives et racines

Zahnzangen | Kids-Extract | Oberkiefer

Extracting forceps | Kids-Extract | Upper Jaw
Daviers | Kids-Extract | Mandibule Supérieure



3.2.1, 1.2.3.

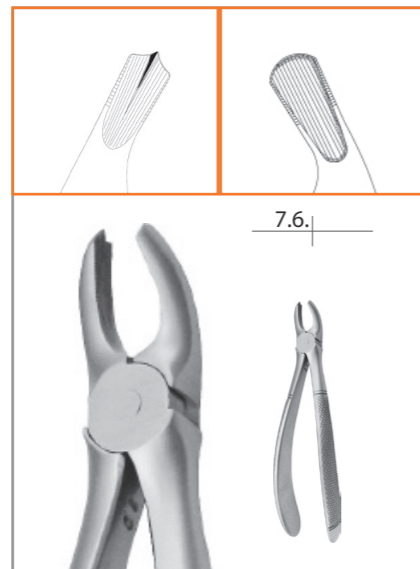

7.6.

02-650-39 R		
02-500-39 R		
# 39 R	140 mm	
Molaren, rechts Molars, right Molaires, droit		

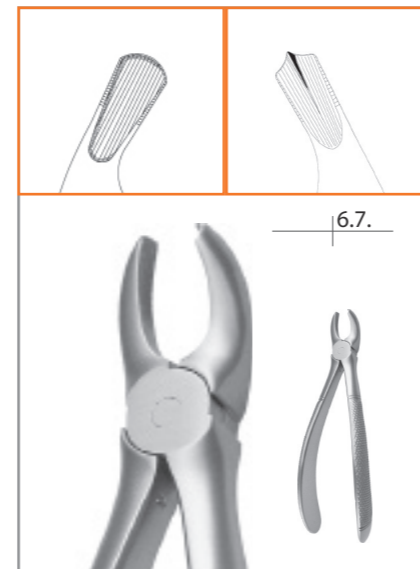

6.7.

02-650-39 L		
02-500-39 L		
# 39 L	140 mm	
Molaren, links Molars, left Molaires, gauche		

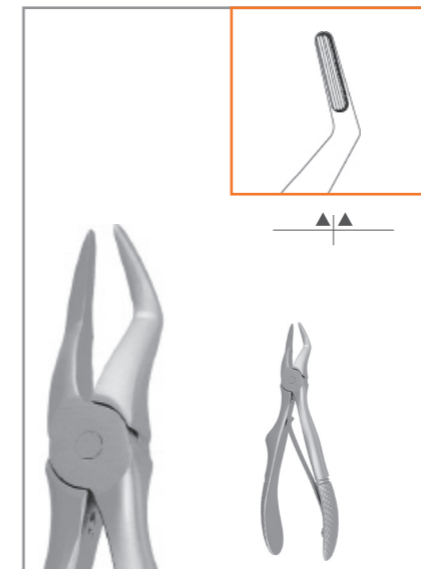

7.6, 6.7.

02-562		
# 51 S Klein	120 mm	
Wurzeln Roots Racines		

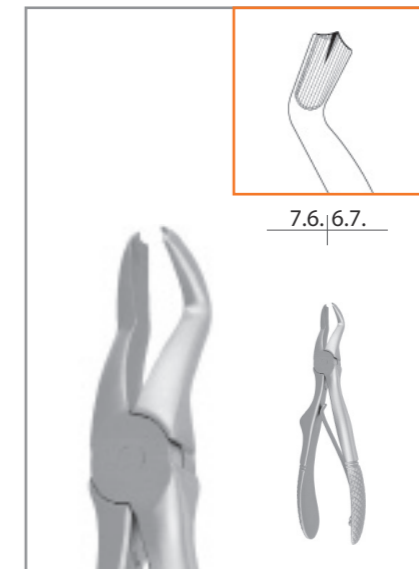

8.7...2.1, 1.2...7.8.

02-563		
# 3 Klein	125 mm	
Molaren Molars Molaires		



02-600-101 ASP		
02-600-101 AS		
# 101 AS	155 mm	
Zähne, universal Teeth, universal Dents, universel		



3.2.1, 1.2.3.

02-500-37		
# 37	145 mm	
Schneide- und Eckzähne Incisors and cuspids Incisives et canines		

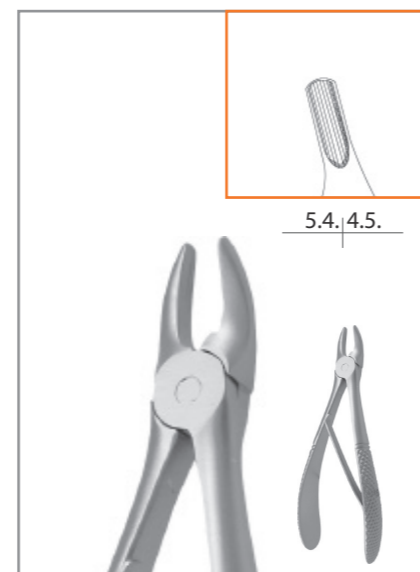

5.4, 4.5.

02-560		
# 137 Klein	115 mm	
Schneide- und Eckzähne Incisors and cuspids Incisives et canines		



8.7...2.1, 1.2...7.8.

02-600-150 AS		
# 150 AS	150 mm	
Zähne, universal Teeth, universal Dents, universel		

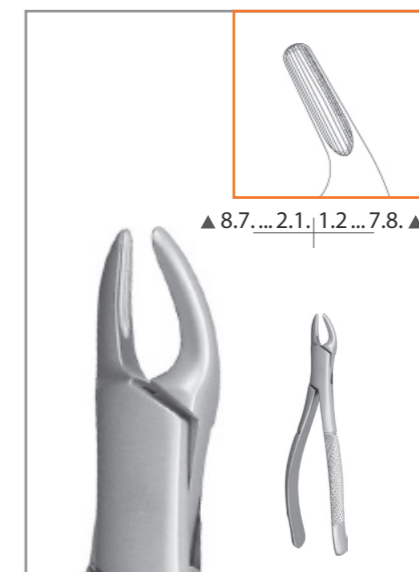

▲ 8.7...2.1, 1.2...7.8. ▲

02-600-150 S		
# 150 S Cryer	155 mm	
Zähne und Wurzeln, universal Teeth and roots, universal Dents et racines, universel		

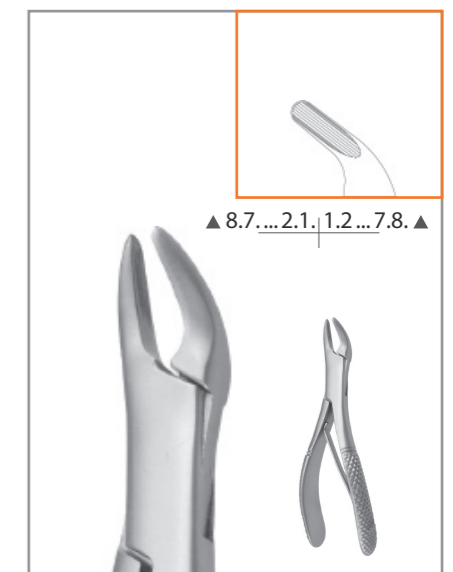

▲ 8.7...2.1, 1.2...7.8. ▲

02-645-150 SKP		
02-645-150 SK		
# 150 SK	125 mm	
Zähne und Wurzeln, universal Teeth and roots, universal Dents et racines, universel		

Zahnzangen | Kids-Extract | Unterkiefer

Extracting forceps | Kids-Extract | Lower Jaw
Daviers | Kids-Extract | Mandibule Inférieure



02-133 ASP
02-133 AS
130 mm
Universal
Universal
Universel



02-500-13 S
13 S 130 mm
Prämolaren
Biscuspids
Prémolaires



02-650-22 S
02-500-22 S
22 S 130 mm
Molaren
Molars
Molaires

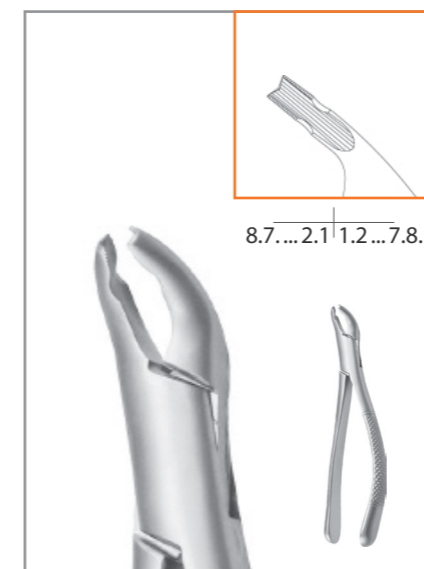

02-600-151 AS
151 AS 150 mm
Universal
Universal
Universel



02-600-151 S
151 S 145 mm
Zähne und Wurzeln, universal
Teeth and roots, universal
Dents et racines, universel

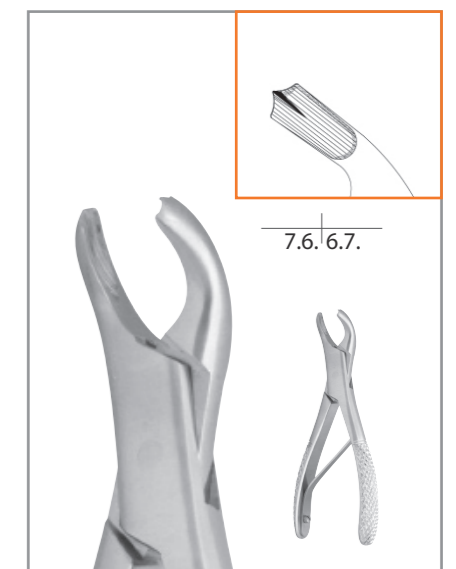

02-645-17 SK
17 SK 120 mm
Molaren
Molars
Molaires



02-565
5 Klein 105 mm
Schneidezähne
Incisors
Incisives



02-567
7 105 mm
Wurzeln
Roots
Racines



02-566
6 Klein 105 mm
Molaren
Molars
Molaires



02-640-23 S
23 S 150 mm
Molaren
Molars
Molaires



02-645-23 SK
23 SK 120 mm
Molaren
Molars
Molaires



02-645-151 SKP
02-645-151 SK
151 SK 120 mm
Zähne und Wurzeln, universal
Teeth and roots, universal
Dents et racines, universel

Notizen

Notes

Notation
